

# UHF RFID System

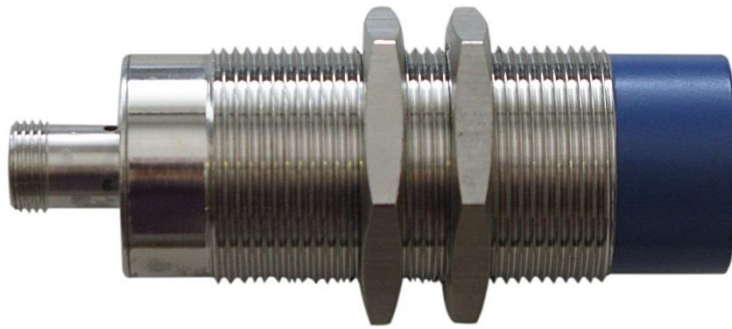

## M30 Form Factor BLUEBOX ADVANT UHF

**BLUEBOX**  
RFid System

## Preface

iDTRONIC GmbH (IDTRONIC) reserves the right to make changes to its products or services or to discontinue any product or service at any time without notice. IDTRONIC provides customer assistance in various technical areas, but, does not have full access to data concerning the use and applications of customer's products. Therefore, IDTRONIC assumes no liability and is not responsible for customer applications or product or software design or performance relating to systems or applications incorporating IDTRONIC products. In addition, IDTRONIC assumes no liability and is not responsible for infringement of patents and/or any other intellectual or industrial property rights of third parties, which may result from assistance provided by IDTRONIC. IDTRONIC products are not designed, intended, authorized or warranted to be suitable for life support applications or any other life critical applications that could involve potential risk of death, personal injury or severe property or environmental damage. With the edition of this document, all previous editions become void. Indications made in this manual may be changed without previous notice. Composition of the information in this manual has been done to the best of our knowledge. IDTRONIC does not guarantee the correctness and completeness of the details given in this manual and may not be held liable for damages ensuing from incorrect or incomplete information. Since, despite all our efforts, errors may not be completely avoided, we are always grateful for your useful tips. The installation instructions given in this manual are based on advantageous boundary conditions. IDTRONIC does not give any guarantee promise for perfect function in cross environments. The companies or products mentioned in this document might be brands or brand names of the different suppliers or their subsidiaries in any country. This document may be downloaded onto a computer, stored and duplicated as necessary to support the use of the related IDTRONIC products. Any other type of duplication, circulation or storage on data carriers in any manner not authorized by IDTRONIC represents a violation of the applicable copyright laws and shall be prosecuted.

iDTRONIC GmbH  
Donnersbergweg 1  
67059 Ludwigshafen  
Germany/Deutschland

Phone: +49 621 6690094-0  
Fax: +49 621 6690094-9  
E-Mail: [info@idtronic.de](mailto:info@idtronic.de)  
Web: [idtronic.de](http://idtronic.de)

Issue 1.17  
– 23. June 2020 –  
Subject to alteration without prior notice.  
© Copyright iDTRONIC GmbH 2020  
Printed in Germany

**Safety Instructions / Warning - Read before start-up!**

- The device may only be used for the intended purpose designed by the manufacturer. The operation manual should be conveniently kept available at all times for each user.
- Unauthorized changes and the use of spare parts and additional devices that have not been sold or recommended by the manufacturer may cause fire, electric shocks or injuries. Such unauthorized measures shall exclude any liability by the manufacturer.
- The liability-prescriptions of the manufacturer in the issue valid at the time of purchase are valid for the device. The manufacturer shall not be held legally responsible for inaccuracies, errors, or omissions in the manual or automatically set parameters for a device or for an incorrect application of a device.
- Repairs may be executed by the manufacturer only.
- Only qualified personnel should carry out installation, operation, and maintenance procedures.
- Use of the device and its installation must be in accordance with national legal requirements and local electrical codes.
- When working on devices the valid safety regulations must be observed.



IP65



**This manual applies to the following devices:**

**Description:**

**Order Number:**

Read / write RFID UHF device with integrated antenna. Serial RS232 communication interface. EU (865 MHz ... 868MHz) version.

5224U

Read / write RFID UHF device with integrated antenna. Serial RS485 communication interface. EU (865 MHz ... 868MHz) version.

5225U

Read / write RFID UHF device with integrated antenna. CAN bus communication interface with SAE J1939 protocol. EU (865 MHz ... 868MHz) version.

5226U



**This manual is valid as of firmware version:**

Order Number	Hardware Version	Firmware Version
5224U	1	1.61
5225U	1	1.61
5226U	1	1.61
5224U	2	2.61
5225U	2	2.61
5226U	2	2.61



Items 5224U, 5225U and 5226U with hardware version 1 and firmware version 1.xx are obsolete items and no long available!



Items 5224U, 5225U and 5226U with hardware version 1 and firmware version 1.xx could be upgraded only with firmware version 1.xx!



Items 5224U, 5225U and 5226U with hardware version 2 and firmware version 2.xx could be upgraded only with firmware version 2.xx!

**Hereinafter the product identification system:**

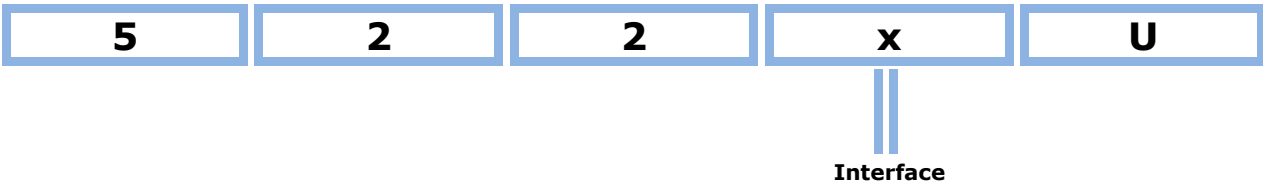

<b>Interface:</b>	4	=	Serial RS232
	5	=	Serial RS485
	6	=	CAN bus

## Table of Contents

1	Introduction.....	7
2	Technical Specifications .....	8
2.1	Electrical Features.....	8
2.1.1	Electrical Features 5224U.....	8
2.1.2	Electrical Features 5225U.....	8
2.1.3	Electrical Features 5226U.....	9
2.2	Mechanical Features .....	9
2.3	Environmental Conditions.....	10
3	Operating Features .....	11
3.1	General Parameters.....	13
3.2	Configuration Parameters.....	15
3.2.1	CAN Bus Interface .....	15
3.2.2	'Spontaneous' Message .....	16
3.2.3	RF and EPC C1G2 (Class-1 Generation-2).....	19
3.2.4	Dynamic Power Management .....	27
3.2.5	RF Tuning.....	28
3.3	Device Status .....	29
4	Communication Features .....	31
4.1	Device Startup.....	32
5	'BLUEBOX M30 Config' Software .....	34
5.1	Software Startup .....	34
5.2	Menu.....	34
5.2.1	File Menu .....	35
5.2.2	Info Menu .....	35
5.3	Software Usage .....	36
6	Installation .....	37
6.1	General Instructions .....	37
6.2	Notes on Tag Mounting .....	37
6.3	Avoiding Interference .....	37
6.4	Mechanical Design.....	38
6.5	Fixing .....	38
6.6	Mounting Distances .....	39
6.7	Positioning of the Tags.....	39
7	Electrical Connections .....	40
7.1	Electrical Connections 5224U.....	41
7.1.1	Power Supply and Serial Line.....	41
7.2	Electrical Connections 5225U.....	42
7.2.1	Power Supply and Serial Line.....	42
7.3	Electrical Connections 5226U.....	43
7.3.1	Power Supply and CAN bus.....	43
8	Status Indications.....	44
9	Antenna .....	45
10	Maintenance, Repair and Disposal.....	46
11	Regulatory Compliance.....	47

11.1 CE Compliance.....47

12 Mechanical Drawings.....48

13 Document Revision History .....49

A. Regions of Operation.....53

    A.1. Operation in Europe .....53

    A.2. Operation in North America .....54

    A.3. Operation in Brazil .....55

B. RS232 DB9 to M12 Connection.....58

## 1 Introduction

The **BLUEBOX GEN2 M30 UHF** hereinafter named **BLUEBOX** is a little (dimensions of the cylindrical case D30 mm x 90.65 mm) read/write RFID device operating in the 840 MHz to 960 MHz frequency band and suitable for industrial application. The **BLUEBOX** communicates with a 'host' system (typically a PC or a PLC) through an RS232 serial line (item 5224U) or an RS485 serial line (item 5225U) or CAN bus communication interface with SAE J1939 protocol (item 5226U) and acts as a joint through a set of commands between the host system and a RFID tag present near the antenna. A 'master/slave' protocol is used for the communication between the 'host' system and the **BLUEBOX**. The **BLUEBOX** is equipped with an integrated RF antenna inside the case and with a 5-poles M12 A-coded male connector.

## 2 Technical Specifications

### 2.1 Electrical Features

#### 2.1.1 Electrical Features 5224U

Power Supply	10 ... 36 Vdc
Power Rating	4W@24dBm
Operating Frequency	865 MHz ... 868 MHz
RF Transmit Power	Max 0.25W (24dBm) conducted
RF Receive Sensitivity	Max -87dBm
Antenna	Integrated
Reading Distance	40cm <sup>1</sup>
Supported Transponders	ISO 18000-63 <sup>2</sup> (EPC Class-1 Gen-2 V2)
Communication Interface	Serial RS232
Status Display	1 bicolor LED
Connections	5-poles M12 A-coded male connector

#### 2.1.2 Electrical Features 5225U

Power Supply	10 ... 36 Vdc
Power Rating	4W@24dBm
Operating Frequency	865 MHz ... 868 MHz
RF Transmit Power	Max 0.25W (24dBm) conducted
RF Receive Sensitivity	Max -87dBm
Antenna	Integrated

<sup>1</sup> Reading distance depends on transponder type, antenna and environmental conditions.

<sup>2</sup> ISO 18000-6C became ISO 18000-63 in 2012 due to ISO naming rules that do not allow letters in standards names.



Reading Distance	40cm <sup>3</sup>
Supported Transponders	ISO 18000-63 <sup>4</sup> (EPC Class-1 Gen-2 V2)
Communication Interface	Serial RS485
Status Display	1 bicolor LED
Connections	5-poles M12 A-coded male connector

### 2.1.3 Electrical Features 5226U

Power Supply	10 ... 36 Vdc
Power Rating	4W@24dBm
Operating Frequency	865 MHz ... 868 MHz
RF Transmit Power	Max 0.25W (24dBm) conducted
RF Receive Sensitivity	Max -87dBm
Antenna	Integrated
Reading Distance	40cm <sup>5</sup>
Supported Transponders	ISO 18000-63 <sup>6</sup> (EPC Class-1 Gen-2 V2)
Communication Interface	CAN bus with SAE J1939 protocol
Status Display	1 bicolor LED
Connections	5-poles M12 A-coded male connector

### 2.2 Mechanical Features

Dimensions	M30 x 90.65 mm
Material	Nickelled brass, PC
Protection Class	IP65

<sup>3</sup> Reading distance depends on transponder type, antenna and environmental conditions.

<sup>4</sup> ISO 18000-6C became ISO 18000-63 in 2012 due to ISO naming rules that do not allow letters in standards names.

<sup>5</sup> Reading distance depends on transponder type, antenna and environmental conditions.

<sup>6</sup> ISO 18000-6C became ISO 18000-63 in 2012 due to ISO naming rules that do not allow letters in standards names.

## 2.3 Environmental Conditions

Operating Temperature	-20°C ... +55°C
Storage Temperature	-40°C ... +85°C
Humidity	Up to 95%, non condensing

### 3 Operating Features

In 'continuous' mode the **BLUEBOX** is characterized by the coexistence of 2 'parallel' and asynchronous activities: the tag identification (inventory) and the communication with the 'host' system. The 'continuous' identification activity interacts with the communication activity through a buffer that contains the code of the last identified tags or that is empty indicating the absence of tags. Due to synchronization and filtering reasons, the buffer is handled for each identified tag by a parameter defined as 'hold time' (same as 'filter time' defined below, to be set in the range of 0 ... 99 seconds or 0 ... 99 minutes, default value 1 second) and allows to extend 'artificially' the presence of the tag after it leaves the antenna's influence area; this behavior is observable looking at the green led status that is 'on' indicating the presence of tag. Through the command 'buffer data request' it is possible to get the data contained in the buffer.

The **BLUEBOX** handles also a 32 elements FIFO queue which is combined with the 'filter time' general parameter (to be set in a range of 0 ... 99 seconds or 0 ... 99 minutes, default value 1 second) that prevents the queue saturation in case of a tag 'continuous' presence. When a tag is identified, the **BLUEBOX** verifies if it belongs to the list of read tags. If the tag do not belong to the list (it is defined as 'new'), its code will be inserted in the queue, a filter time assigned to the tag will be started. Otherwise (the tag belong to the list of read tags), the **BLUEBOX** verifies if the relative filter time is expired. In this case (the filter time is expired), the tag is defined as 'new' and will be processed as described above, otherwise only the relative filter time will be rearmed. Through the command 'queue data request' and the relative 'ACK, it is possible to get the data contained in the queue and unload it.



Buffer and FIFO queue will hold onto a maximum of 82 bytes of tag data. Once the 82 bytes of tag data limit is reached, the exceeded bytes will be discarded!

In 'continuous' mode the **BLUEBOX** can be configured to obtain the behavior of a 'spontaneous' reader that will send a message on the serial line or CAN bus every time that a 'new' transponder is identified (or for every identified tag according to 'spontaneous' message mode configuration). This feature is enabled (on) / disabled (off) using a flag in the general configuration of the reader.

- If configured and available an host can receive the 'spontaneous' message through the serial port. The 'spontaneous' message is sent only once and no ACK/NAK reply message is implemented, see the protocol manual for details. Do not use the 'spontaneous' message feature in a RS485 'multipoint' network to avoid communication errors due to unmanaged collisions on RS485 bus!

- If configured and available an host can wait for incoming 'spontaneous' messages through CAN bus interface. The 'spontaneous' message is sent only once and no ACK/NAK reply message is implemented except of the normal CAN bus handshake mechanism, see the protocol manual for details.



In case of a 'spontaneous' message send error, due to a connection or communication error, no further attempts will be made and the tag will be discarded!



**BLUEBOX** will hold onto a maximum of 10 tags when configured to use the 'spontaneous' message. Once the 10 tag limit is reached, the new tags will be discarded!

---

The **BLUEBOX** allows the execution of 'on request' functions. During the execution of these functions, the 'continuous' identification activity will be suspended temporarily; the involved commands are relative to the read/write specific activities of the supported transponders.

If not required, the 'continuous' identification activity can be disabled through a flag defined in the parameters. In this case, the **BLUEBOX** will only execute the 'on request' commands already defined above.

'Test' modes are also defined:

- 'RF Power' test: allows the user to easily and quickly test the minimum RF output power needed to read a tag in a fixed position. The reader sweeps from the minimum RF output power to maximum RF output power or until it finds a tag, increasing the RF power of 1 dB every 500ms with fixed Q selection algorithm and  $Q=0$ . It is an 'on request' function which temporarily suspends the 'continuous' mode.
- 'RF Sensitivity' test: allows the user to easily and quickly test the minimum RF input sensitivity needed to read a tag in a fixed position. The reader sweeps from the minimum RF input sensitivity to maximum RF input sensitivity or until it finds a tag, increasing the RF sensitivity of 1 dB every 500ms with fixed Q selection algorithm and  $Q=0$ . It is an 'on request' function which temporarily suspends the 'continuous' mode.
- Read Reflected Power: allows the user to read the reflected power of the antenna at a given frequency to check the antenna connection.
- Read RSSI: allows the user to read the signal strength received by the antenna at a given frequency to check the presence of external RF sources.

The **BLUEBOX** integrates a reconfigurable RF carrier leakage canceler feature which allows the usage of the reader in many different environments and configurations. The RF carrier leakage canceler adaption is done at every power on and during normal operations of the reader based on RF tuning configuration parameters described in next sections.



Only items 5224U, 5225U and 5226U with hardware version 2 and firmware version 2.xx integrates the reconfigurable RF carrier leakage canceler feature!

### 3.1 General Parameters

Parameter	Description	Range	Default
Device Address	Device address of the reader on serial interface.	0 ... 255	255
Baud Rate	Communication baud rate on serial interface.	1200 2400 4800 9600 19200 38400 57600 115200	19200
Data Bits	Data bits on serial interface.	7 8	8
Stop Bits	Stop bits on serial interface.	1 2	1
Parity	Parity on serial interface.	None Even Odd	None
Filter Time	Reading and tag queue management filter time.  Note that 0 setting is internally overwritten with 1 second.	0 ... 99 sec 0 ... 99 min	1 second
Reading Antenna Information	To add the reading antenna information to the tag's code.	Disabled Enabled	Disabled
Transponder Type Information	To add the transponder type information in the tag's code.	Disabled Enabled	Disabled
'Spontaneous' Mode	Spontaneous mode.	Disabled Enabled	Disabled

Parameter	Description	Range	Default
'Continuous' Mode	'Continuous' mode.	Disabled Enabled	Enabled

The general parameters are managed through the 'Read General Parameters' and 'Write General Parameters' commands as described in protocol technical manuals where the parameters 1...7 fields with default values are:

1	2	3	4	5	6	7
Device Address	Serial1	Serial2	0x00	0x00	Filter Time	Functional Flags
0xFF	0x48	0x10	0x00	0x00	0x01	0x80



Where:

Parameter	Description
Device Address	Device address of the reader on serial interface in the range 0 ... 255.
Serial1	Serial interface communication settings. <ul style="list-style-type: none"> <li>High nibble: baud rate: <ul style="list-style-type: none"> <li>0x0: 1200 bps;</li> <li>0x1: 2400 bps;</li> <li>0x2: 4800 bps;</li> <li>0x3: 9600 bps;</li> <li>0x4: 19200 bps;</li> <li>0x5: 38400 bps;</li> <li>0x6: 57600 bps;</li> <li>0x7: 115200 bps.</li> </ul> </li> <li>Low nibble: data bits: <ul style="list-style-type: none"> <li>0x7: 7 bits;</li> <li>0x8: 8 bits.</li> </ul> </li> </ul>
Serial2	Serial interface communication settings. <ul style="list-style-type: none"> <li>High nibble: stop bits: <ul style="list-style-type: none"> <li>0x1: 1 bits;</li> <li>0x2: 2 bits.</li> </ul> </li> <li>Low nibble: parity: <ul style="list-style-type: none"> <li>0x0: None;</li> <li>0x1: Even;</li> <li>0x2: Odd.</li> </ul> </li> </ul>
Filter Time	Reading management filter time (0 setting is internally overwritten with 1 second): <ul style="list-style-type: none"> <li>Decimal 0 ... 99 for time in seconds (0 ... 99 seconds);</li> <li>Decimal 100 ... 199 for time in minutes (0 ... 99 minutes).</li> </ul>
Functional Flags	Functional flags. Single bits are dedicated to disable (0 value) or enable (1 value) functions:

Parameter	Description
	<ul style="list-style-type: none"> <li>• Bit 7: Not used;</li> <li>• Bit 6: Not used;</li> <li>• Bit 5: Reading antenna information;</li> <li>• Bit 4: Transponder type information;</li> <li>• Bit 3: 'Spontaneous' mode;</li> <li>• Bit 2: Not used;</li> <li>• Bit 1: Not used;</li> <li>• Bit 0: 'Continuous' mode (0=enabled, 1=disabled).</li> </ul>

## 3.2 Configuration Parameters

### 3.2.1 CAN Bus Interface

Parameter	Description	Range	Default
Node ID	The CAN bus node ID of the reader.  Note that this parameter become effective only after a reboot of the reader.	0 ... 253	235
Bitrate	The CAN bus bitrate.  Note that this parameter become effective only after a reboot of the reader.	250 kbit/s 500 kbit/s	250 kbit/s



The CAN bus interface parameters are stored in configuration page nr. 0x83 and are managed through the 'Read RAM/ROM Configuration Parameters' and 'Write RAM/ROM Configuration Parameters' commands as described in protocol technical manuals where the parameters 1...14 fields with default values are:

1	2	3	4	5	6	7
Node ID	Bitrate	0x00	0x00	0x00	0x00	0x00
..	..	0x00	0x00	0x00	0x00	0x00
8	9	10	11	12	13	14
0x00	0x00	0x00	0x00	0x00	0x00	0x00
0x00	0x00	0x00	0x00	0x00	0x00	0x00

Where:

Parameter	Description
Node ID	The CAN bus node ID of the reader in the range 0 ... 253.
Bitrate	The CAN bus bitrate: <ul style="list-style-type: none"> <li>• 0x05: 250 kbit/s</li> <li>• 0x06: 500 kbit/s</li> </ul>

### 3.2.2 'Spontaneous' Message

Parameter	Description	Range	Default
Message Trigger	<p>The 'spontaneous' message trigger event:</p> <ul style="list-style-type: none"> <li>• 0: One 'spontaneous' message for every 'new tag';</li> <li>• 1: One 'spontaneous' message for every identified tag (slow mode with a filter time of 100ms).</li> </ul> <p> Note that this parameter become effective only after a reboot of the reader.</p>	0 1	0
Message on Serial Interface	<p>'Spontaneous' message on serial interface.</p> <p> Note that this parameter become effective only after a reboot of the reader.</p>	Disabled Enabled	Enabled
Message on CAN bus Interface	<p>'Spontaneous' message on CAN bus interface.</p> <p> Note that this parameter become effective only after a reboot of the reader.</p>	Disabled Enabled	Enabled
Format	<p>The 'spontaneous' message format.</p> <ul style="list-style-type: none"> <li>• 0: Message is sent with BlueBox protocol rules;</li> <li>• 1: Message is sent, without any control character, in dual char string form;</li> <li>• 2: Message is sent like in option 1 but at the end CR will be appended;</li> <li>• 3: Message is sent like in option 1 but at the end CR+LF will be appended.</li> <li>• 4: Message is sent, without any control character, in ASCII form. Non printable chars (0x20..0x7E) are replaced with '\.' (0x2E).</li> <li>• 5: Message is sent like in option 4 but at the end CR will be appended.</li> <li>• 6: Message is sent like in option 4 but at the end CR+LF will be appended.</li> <li>• 7: Message is sent like in option 1 with an STX char at the begin of the message.</li> </ul>	0 1 2 3 4 5 6 7 8 9 10 11 12	0



Parameter	Description	Range	Default
	<ul style="list-style-type: none"> <li>8: Message is sent like in option 2 with an STX char at the begin of the message.</li> <li>9: Message is sent like in option 3 with an STX char at the begin of the message.</li> <li>10: Message is sent like in option 4 with an STX char at the begin of the message.</li> <li>11: Message is sent like in option 5 with an STX char at the begin of the message.</li> <li>12: Message is sent like in option 6 with an STX char at the begin of the message.</li> </ul>  Note that this parameter become effective only after a reboot of the reader.		
Encoding	The 'spontaneous' message encoding.	None Decimal	None

The 'spontaneous' message format and encoding allowed values are

Format	Encoding
0	None
1	None
2	None
3	None
4	None, Decimal
5	None, Decimal
6	None, Decimal
7	None
8	None
9	None
10	None, Decimal
11	None, Decimal
12	None, Decimal

The 'spontaneous' message parameters are stored in configuration page nr. 0x09 and are managed through the 'Read RAM/ROM Configuration Parameters' and 'Write RAM/ROM Configuration Parameters' commands as described in

protocol technical manuals where the parameters 1...7 fields with default values are:

1	2	3	4	5	6	7
Message Trigger	Interface	Format	Encoding	0x00	0x00	0x00
0x00	0x00	0x00	0x00	0x00	0x00	0x00







Where:





Parameter	Description
Message Trigger	<p>The 'spontaneous' message trigger event:</p> <ul style="list-style-type: none"> <li>• 0x00: One 'spontaneous' message for every 'new tag';</li> <li>• 0x01: One 'spontaneous' message for every identified tag (slow mode with a filter time of 100ms).</li> </ul>
Interface	<p>The interface where to send the 'spontaneous' message activation/deactivation. Single bits are dedicated to enable (0 value) or disable (1 value) an interface:</p> <ul style="list-style-type: none"> <li>• Bit 7: Not used;</li> <li>• Bit 6: Not used;</li> <li>• Bit 5: Not used;</li> <li>• Bit 4: CAN bus interface;</li> <li>• Bit 3: Not used;</li> <li>• Bit 2: Not used;</li> <li>• Bit 1: Not used;</li> <li>• Bit 0: Serial interface.</li> </ul>
Format	<p>The 'spontaneous' message format:</p> <ul style="list-style-type: none"> <li>• 0x00: Message is sent with BlueBox protocol rules;</li> <li>• 0x01: Message is sent, without any control character, in dual char string form;</li> <li>• 0x02: Message is sent like in option 1 but at the end CR will be appended;</li> <li>• 0x03: Message is sent like in option 1 but at the end CR+LF will be appended.</li> <li>• 0x04: Message is sent, without any control character, in ASCII form. Non printable chars (0x20..0x7E) are replaced with '.' (0x2E).</li> <li>• 0x05: Message is sent like in option 4 but at the end CR will be appended.</li> <li>• 0x06: Message is sent like in option 4 but at the end CR+LF will be appended.</li> <li>• 0x07: Message is sent like in option 1 with an STX char at the begin of the message.</li> <li>• 0x08: Message is sent like in option 2 with an STX char at the begin of the message.</li> <li>• 0x09: Message is sent like in option 3 with an STX char at the begin of the message.</li> <li>• 0x0A: Message is sent like in option 4 with an STX char at the begin of the message.</li> <li>• 0x0B: Message is sent like in option 5 with an STX char at the begin of the message.</li> </ul>

Parameter	Description
	<ul style="list-style-type: none"> <li>0x0C: Message is sent like in option 6 with an STX char at the begin of the message.</li> </ul>
Encoding	The 'spontaneous' message encoding: <ul style="list-style-type: none"> <li>0x00: None;</li> <li>0x01: Decimal.</li> </ul>

### 3.2.3 RF and EPC C1G2 (Class-1 Generation-2)



Hereinafter the configurable RF parameters of the **BLUEBOX**.





Parameter	Description	Range	Default
RF Geographical Region	RF geographical region.  Note that ETSI, FCC and Brazil readers cannot be altered and only operate per the regulatory laws in the EU, USA/Canada and Brazil.	EU1: ETSI FCC: FCC BRA: Brazil	EU1: ETSI FCC: FCC BRA: Brazil
RF Transmit Power	RF conducted transmit power in dBm.  Refer to country specific regulations for limitations. You, the user, are responsible to ensure operation with the correct RF settings and are solely responsible for any fines and other damages due to incorrect or non-compliant country/region settings.	0 ... 24 dBm	20 dBm
RF Receive Sensitivity	RF receive sensitivity in dBm.	-51 ... -87 dBm	-76 dBm
RF Channel	RF channel.  Note that 0 value stands for default settings of the selected region.  Refer to country specific regulations for channel allocation within the band. You, the user, are responsible to ensure operation with the correct RF settings and are solely responsible for any fines and other damages due to incorrect or non-compliant country/region settings.	EU1: 0 ... 10 FCC: 0 ... 50 BRA: 0 ... 50	0
Antenna 1 Activation	Activation of antenna 1.	Disabled Enabled	Enabled
RF Channel Allocation Time	The maximum period of consecutive transmission on the same RF channel.  Note that 0 value stands for default settings of the selected region.  Refer to country specific regulations for limitations. You, the user, are responsible to	0.00 ... 0.99 seconds 0 ... 99 seconds	0

Parameter	Description	Range	Default
	ensure operation with the correct RF settings and are solely responsible for any fines and other damages due to incorrect or non-compliant country/region settings.		
RF Channel Pause Time	The minimum time between two consecutive transmissions in the same RF channel.  Note that 0 value stands for default settings of the selected region.  Refer to country specific regulations for limitations. You, the user, are responsible to ensure operation with the correct RF settings and are solely responsible for any fines and other damages due to incorrect or non-compliant country/region settings.	0.00 ... 0.99 seconds 0 ... 99 seconds	0
RF Chip Standby Mode	Activation / deactivation of the standby mode of the RF chip during RF off conditions to reduce power consumption and temperature increase.	Disabled Enabled	Enabled
RSSI Information	The detection tag's signal RSSI I and Q measured values information.  Note that this parameter become effective only after a reboot of the reader.	Disabled Enabled	Disabled
Max RSSI Information	The detected tag's signal max RSSI I and Q measured values information.  Note that this parameter become effective only after a reboot of the reader.	Disabled Enabled	Disabled
Tag Read Count Information	The tag read count information.  Note that this parameter become effective only after a reboot of the reader.	Disabled Enabled	Disabled

Hereinafter the configurable EPC C1G2 (Class-1 Generation-2) parameters of the **BLUEBOX**.

Parameter	Description	Range	Default
Inventory Mode	How the reader does an inventory in 'continuous' mode.	Fast Multi Tag Fast Single Tag Standard Multi Tag Standard Single Tag	Standard Multi Tag
R->T Link Frequency	R->T Link Frequency as defined in EPC Class 1 Generation 2 protocol.	40 kHz 160 kHz 256 kHz 320 kHz 640 kHz	160 kHz

Parameter	Description	Range	Default
R->T Bit Coding	R->T Bit coding as defined in EPC Class 1 Generation 2 protocol.	FM0 Miller 2 Miller 4 Miller 8	Miller 2
Q Selection Algorithm	The Q selection algorithm used for setting the slot-counter parameter as defined in EPC Class 1 Generation 2 protocol.	Dynamic Fixed	Dynamic
Q Value	The Q value used in fixed Q selection algorithm or the starting Q value used in dynamic Q selection algorithm as defined in EPC Class 1 Generation 2 protocol.	0 ... 15	3
Q Initial	The minimum allowed Q value in dynamic Q algorithm mode.	0 ... 15	0
Q Final	The maximum allowed Q value in dynamic Q algorithm mode.	0 ... 15	4
Q Adjust Rounds	The maximum Q adjust rounds in dynamic Q algorithm mode.	0 ... 5	3
Inventory Cycles	The inventory cycles in inventory command.	0 ... 5	3
Search Mode	How the reader singulates (select) tags in 'continuous' mode.	Dual Target Single Target	Dual Target
Session	The session used as defined in EPC Class 1 Generation 2 protocol.	S0 S1 S2 S3	S0
Target	The target used as defined in EPC Class 1 Generation 2 protocol.	A B	A
EPC size	The size of the recognized EPC in bytes. 0 means all EPC sizes,	0 ... 62	0
ReadAfterDetect Activation	Activation of the ReadAfterDetect mode in 'continuous' mode.  Note that this parameter become effective only after a reboot of the reader.	None TID Custom	None
ReadAfterDetect Password	The password to be used to access to tag's memory in ReadAfterDetect mode (Inventory Mode = Standard Single/Multi Tag with Custom Info). Use a '0' password if the access password is not requested.  Note that this parameter become effective only after a reboot of the reader.	0x00 0x00 0x00 0x00 ... 0xFF 0xFF 0xFF 0xFF	0x00 0x00 0x00 0x00

Parameter	Description	Range	Default
ReadAfterDetect Bank	The tag's memory bank to access in ReadAfterDetect mode (Inventory Mode = Standard Single/Multi Tag with Custom Info).  Note that this parameter become effective only after a reboot of the reader.	Reserved EPC TID User	Reserved
ReadAfterDetect Address	The tag's memory start address to access in the specified memory bank in ReadAfterDetect mode (Inventory Mode = Standard Single/Multi Tag with Custom Info).  Note that this parameter become effective only after a reboot of the reader.	0x00 0x00 0x00 0x00 ... 0xFF 0xFF 0xFF 0xFF	0x00 0x00 0x00 0x00
ReadAfterDetect Length	The number of tag's memory blocks (2-bytes length) to access in the specified memory bank in ReadAfterDetect mode (Inventory Mode = Standard Single/Multi Tag with Custom Info). In case of Reserved or User bank selected 0 means no tag's memory block access, in case of TID bank selected 0 means auto-length (class identifier, manufacturer identifier, serial number).  Note that this parameter become effective only after a reboot of the reader.	0 ... 255	0
ReadAfterDetect Info Flags	The tag's info (PC, EPC, CRC) to include in the tag's ID in ReadAfterDetect mode (Inventory Mode = Standard Single/Multi Tag with Custom Info).  Note that this parameter become effective only after a reboot of the reader.	PC, EPC, CRC	PC, EPC, CRC
Use AFI	To enable/disable the AFI (Application Family Identifier) management.	Disabled Enabled	Disabled
AFI	The AFI (Application Family Identifier) value.	0 ... 255	0

The RF and EPC C1G2 (Class-1 Generation-2) parameters are stored in configuration pages nr. 0x01, 0x02, 0x04 and 0x82 and are managed through the 'Read RAM/ROM Configuration Parameters' and 'Write RAM/ROM Configuration Parameters' commands as described in protocol technical manuals.

The parameters 1...7 fields with default values are of page 0x01 are:

1	2	3	4	5	6	7
RF Receive Sensitivity	Functional Flags	0x00	0x00	0x00	0x00	0x00
<b>0x4C</b>	<b>0x00</b>	<b>0x00</b>	<b>0x00</b>	<b>0x00</b>	<b>0x00</b>	<b>0x00</b>

Where:

Parameter	Description
RF Receive Sensitivity	Absolute value of the RF receive sensitivity in the range 51 ... 87.
Functional Flags	Flags. Single bits are dedicated to disable (0 value) or enable (1 value) functions: <ul style="list-style-type: none"> <li>• Bit 7: Not used;</li> <li>• Bit 6: Not used</li> <li>• Bit 5: Not used;</li> <li>• Bit 4: Not used;</li> <li>• Bit 3: Max RSSI information;</li> <li>• Bit 2: Tag read count information;</li> <li>• Bit 1: RSSI information;</li> <li>• Bit 0: To disable the RF chip standby mode (0=enabled, 1=disabled).</li> </ul>

The parameters 1...7 fields with default values of page 0x02 are:

1	2	3	4	5	6	7
RF Geograph. Region	RF Transmit Power	RF Channel	Antennas Activation	EPC C1G2	RF Maximum Allocation Time	RF Minimum Pause Time
0x02	0x14	0x00	0x01	0x30	0x00	0x00

Where:

Parameter	Description
RF Geographical Region	RF geographical region: <ul style="list-style-type: none"> <li>• 0x01: North America (FCC compliant);</li> <li>• 0x02: Europe (ETSI compliant);</li> <li>• 0x03: Brazil (FCC subset compliant).</li> </ul>
RF Transmit Power	RF conducted transmit power in the range 0 ... 24.
RF Channel	RF channel. Channel 0 stands for default settings of the selected region.
Antennas Activation	A byte whose bits are dedicated to disable (0 value) or enable (1 value) the antennas to use: <ul style="list-style-type: none"> <li>• Bit 7: Not used.</li> <li>• Bit 6: Not used.</li> <li>• Bit 5: Not used.</li> <li>• Bit 4: Not used.</li> <li>• Bit 3: Not used.</li> <li>• Bit 2: Not used.</li> <li>• Bit 1: Not used.</li> <li>• Bit 0: Antenna 1.</li> </ul>

Parameter	Description
EPC C1G2	<p>A byte whose bits are dedicated to manage Q value and session/target parameters:</p> <ul style="list-style-type: none"> <li>• Bit 7 ... bit 4: Q value in fixed Q selection algorithm or starting Q value in dynamic Q selection algorithm, as defined EPC Class 1 Generation 2 protocol (0x0=0 ... 0xF=15);</li> <li>• Bit 3 ... bit 2: Session as defined in EPC Class 1 Generation 2 protocol (00b=S0, 01b=S1, 10b=S2, 11b=S3);</li> <li>• Bit 1: Q selection algorithm (0=dynamic, 1=fixed);</li> <li>• Bit 0: Target as defined in EPC Class 1 Generation 2 protocol (0=A, 1=B).</li> </ul>
RF Maximum Allocation Time	<p>The maximum period of consecutive transmission on the same RF channel. 0 stands for default settings of the selected region. The allowed values are:</p> <ul style="list-style-type: none"> <li>• Decimal 0 ... 99 for time in mseconds (0.00 ... 0.99 seconds);</li> <li>• Decimal 100 ... 199 for time in seconds (0 ... 99 seconds).</li> </ul>
RF Minimum Pause Time	<p>The minimum time between two consecutive transmission in the same RF channel. 0 stands for default settings of the selected region. The allowed values are:</p> <ul style="list-style-type: none"> <li>• Decimal 0 ... 99 for time in mseconds (0.00 ... 0.99 seconds);</li> <li>• Decimal 100 ... 199 for time in seconds (0 ... 99 seconds).</li> </ul>



The parameters 1...7 fields with default values of page 0x04 are:

1	2	3	4	5	6	7
Inventory Mode	R->T Link Frequency	R->T Bit Coding	0x00	EPC Size	Use AFI	AFI
0x02	0x02	0x01	0x00	0x00	0x00	0x00

Where:

Parameter	Description
Inventory Mode	<p>A byte whose bits are dedicated to manage the inventory mode, the search mode and the ReadAfterDetect info activation parameters:</p> <ul style="list-style-type: none"> <li>• Bit 7: Not used.</li> <li>• Bit 6: Search mode (how the reader singulates tags in 'continuous' mode): <ul style="list-style-type: none"> <li>◦ 0b: Dual Target (the reader singulates tags in both A and B states).</li> <li>◦ 1b: Single Target (the reader singulates only tags that are in A state).</li> </ul> </li> <li>• Bit 5: Activation of the ReadAfterDetect with custom info as defined in ReadAfterDetect Password, Bank, Address, Length and EPC Info parameters (0b=OFF, 1b=ON).</li> <li>• Bit 4: Activation of the ReadAfterDetect with auto TID info (0b=OFF, 1b=ON).</li> <li>• Bit 3 ... bit 0: Inventory mode (how the reader does an inventory in 'continuous' mode): <ul style="list-style-type: none"> <li>◦ 0x0: Fast Multi Tag: Inventory mode that does not take the tag to the Opened but to the Acknowledged state. This inventory mode is not as secure as the standard mode, but it is faster.</li> <li>◦ 0x1: Fast Single Tag: The same inventory mode like the Fast Multi Tag, but with the slot count of 1. This has the effect that no anticollision procedure is performed.</li> </ul> </li> </ul>



Parameter	Description																				
	<ul style="list-style-type: none"> <li>○ 0x2: Standard Multi Tag: Inventory mode like defined in the EPC C1G2 standard.</li> <li>○ 0x4: Standard Single Tag: The same inventory mode like the Standard Multi Tag, but with the slot count of 1. This has the effect that no anticollision procedure is performed.</li> </ul> <p> Note that allowed values are:</p> <table border="1"> <thead> <tr> <th>Inventory Mode</th> <th>ReadAfterDetect with Custom Info</th> <th>ReadAfterDetect with Auto TID</th> <th>Search Mode</th> </tr> </thead> <tbody> <tr> <td>Fast Multi Tag, Fast Single Tag</td> <td>Disabled</td> <td>Disabled</td> <td>Dual Target, Single Target</td> </tr> <tr> <td>Standard Multi Tag, Standard Single Tag</td> <td>Disabled</td> <td>Disabled</td> <td>Dual Target, Single Target</td> </tr> <tr> <td>Standard Multi Tag, Standard Single Tag</td> <td>Disabled</td> <td>Enabled</td> <td>Dual Target, Single Target</td> </tr> <tr> <td>Standard Multi Tag, Standard Single Tag</td> <td>Enabled</td> <td>Disabled</td> <td>Dual Target, Single Target</td> </tr> </tbody> </table>	Inventory Mode	ReadAfterDetect with Custom Info	ReadAfterDetect with Auto TID	Search Mode	Fast Multi Tag, Fast Single Tag	Disabled	Disabled	Dual Target, Single Target	Standard Multi Tag, Standard Single Tag	Disabled	Disabled	Dual Target, Single Target	Standard Multi Tag, Standard Single Tag	Disabled	Enabled	Dual Target, Single Target	Standard Multi Tag, Standard Single Tag	Enabled	Disabled	Dual Target, Single Target
Inventory Mode	ReadAfterDetect with Custom Info	ReadAfterDetect with Auto TID	Search Mode																		
Fast Multi Tag, Fast Single Tag	Disabled	Disabled	Dual Target, Single Target																		
Standard Multi Tag, Standard Single Tag	Disabled	Disabled	Dual Target, Single Target																		
Standard Multi Tag, Standard Single Tag	Disabled	Enabled	Dual Target, Single Target																		
Standard Multi Tag, Standard Single Tag	Enabled	Disabled	Dual Target, Single Target																		
R->T Link Frequency	<p>R-&gt;T link frequency:</p> <ul style="list-style-type: none"> <li>• 0x00: 40 kHz;</li> <li>• 0x02: 160 kHz;</li> <li>• 0x04: 256 kHz;</li> <li>• 0x05: 320 kHz;</li> <li>• 0x06: 640 kHz.</li> </ul>																				
R->T Bit Coding	<p>R-&gt;T bit coding:</p> <ul style="list-style-type: none"> <li>• 0x00: FM0;</li> <li>• 0x01: Miller 2;</li> <li>• 0x02: Milller 4;</li> <li>• 0x03: Miller 8.</li> </ul> <p> Note that allowed values are:</p> <table border="1"> <thead> <tr> <th>R-&gt;T Link Frequency</th> <th>R-&gt;T Bit Coding</th> </tr> </thead> <tbody> <tr> <td>40 kHz</td> <td>FM0, Miller 2, Miller 4, Miller 8</td> </tr> <tr> <td>160 kHz</td> <td>FM0, Miller 2, Miller 4, Miller 8</td> </tr> <tr> <td>256 kHz</td> <td>Miller 4, Miller 8</td> </tr> <tr> <td>320 kHz</td> <td>Miller 4, Miller 8</td> </tr> <tr> <td>640 kHz</td> <td>Miller 4, Miller 8</td> </tr> </tbody> </table> <p> DRM (Dense Reader Mode):</p> <table border="1"> <thead> <tr> <th>R-&gt;T Link Frequency</th> <th>R-&gt;T Bit Coding</th> </tr> </thead> <tbody> <tr> <td>256 kHz</td> <td>Miller 4, Miller 8</td> </tr> <tr> <td>320 kHz</td> <td>Miller 4, Miller 8</td> </tr> </tbody> </table>	R->T Link Frequency	R->T Bit Coding	40 kHz	FM0, Miller 2, Miller 4, Miller 8	160 kHz	FM0, Miller 2, Miller 4, Miller 8	256 kHz	Miller 4, Miller 8	320 kHz	Miller 4, Miller 8	640 kHz	Miller 4, Miller 8	R->T Link Frequency	R->T Bit Coding	256 kHz	Miller 4, Miller 8	320 kHz	Miller 4, Miller 8		
R->T Link Frequency	R->T Bit Coding																				
40 kHz	FM0, Miller 2, Miller 4, Miller 8																				
160 kHz	FM0, Miller 2, Miller 4, Miller 8																				
256 kHz	Miller 4, Miller 8																				
320 kHz	Miller 4, Miller 8																				
640 kHz	Miller 4, Miller 8																				
R->T Link Frequency	R->T Bit Coding																				
256 kHz	Miller 4, Miller 8																				
320 kHz	Miller 4, Miller 8																				
EPC Size	The size of the recognized EPC in bytes. 0 means all EPC sizes.																				

Parameter	Description
Use AFI	To enable/disable the AFI (Application Family Identifier) management: <ul style="list-style-type: none"> <li>0x00: Disabled;</li> <li>0x01: Enabled.</li> </ul>
AFI	The AFI (Application Family Identifier) value.

The parameters 1...14 fields with default values of page 0x82 are:



1	2	3	4	5	6	7
ReadAfterDetect Password0	ReadAfterDetect Password1	ReadAfterDetect Password2	ReadAfterDetect Password3	ReadAfterDetect Bank	ReadAfterDetect Address0	ReadAfterDetect Address1
0x00	0x00	0x00	0x00	0x00	0x00	0x00
8	9	10	11	12	13	14
ReadAfterDetect Address2	ReadAfterDetect Address3	ReadAfterDetect Length	ReadAfterDetect Info Flags	Q	Q Adjust Rounds	Inventory Cycles
0x00	0x00	0x00	0x03	0x05	0x03	0x03

Where:

Parameter	Description
ReadAfterDetect Password0 ... ReadAfterDetect Password3	The password to be used to access to tag's memory in ReadAfterDetect mode. Use a '0' password if the access password is not requested.
ReadAfterDetect Bank	The tag's memory bank to access in ReadAfterDetect mode: <ul style="list-style-type: none"> <li>0x00: Reserved;</li> <li>0x01: EPC;</li> <li>0x02: TID;</li> <li>0x03: User.</li> </ul>
ReadAfterDetect Address0 ... ReadAfterDetect Address3	The tag's memory start address to access in the specified memory bank in ReadAfterDetect mode.
ReadAfterDetect Length	The number of tag's memory blocks (2-bytes length) to access in the specified memory bank in ReadAfterDetect mode. In case of Reserved or User bank selected, 0 means no tag's memory block access; in case of TID bank selected, 0 means auto-length (class identifier, manufacturer identifier, serial number).

Parameter	Description
ReadAfterDetect Info Flags	The tag's info (PC, EPC, CRC) to include in the tag's ID in ReadAfterDetect mode. A byte whose bits are dedicated to disable (0 value) or enable (1 value) functions: <ul style="list-style-type: none"> <li>• Bit 7: Not used;</li> <li>• Bit 6: Not used;</li> <li>• Bit 5: Not used;</li> <li>• Bit 4: Not used;</li> <li>• Bit 3: Not used;</li> <li>• Bit 2: CRC field;</li> <li>• Bit 1: EPC field;</li> <li>• Bit 0: PC field.</li> </ul>
Q	Minimum and maximum Q value to be used in dynamic Q selection algorithm: <ul style="list-style-type: none"> <li>• High nibble: minimum Q value (0x0 ... 0xF);</li> <li>• Low nibble: maximum Q value (0x0 ... 0xF).</li> </ul>
Q Adjust Rounds	Maximum Q adjust rounds in dynamic Q selection algorithm.
Inventory Cycles	The inventory cycles in inventory command.

### 3.2.4 Dynamic Power Management

Parameter	Description	Range	Default
Mode	How the reader manages the power in 'continuous' mode.  Note that this parameter become effective only after a reboot of the reader.	Off Up Up/down	Off
Power Step	The power step in dynamic power management mode activated.  Note that this parameter become effective only after a reboot of the reader.	1 ... 5 dB 10 ... 500 mW	1 dB
Time Step	The time step in dynamic power management mode activated.  Note that this parameter become effective only after a reboot of the reader.	0.1 ... 9.9 seconds	1.0 sec

The Input/Output parameters are stored in configuration page nr. 0x07 and are managed through the 'Read RAM/ROM Configuration Parameters' and 'Write RAM/ROM Configuration Parameters' commands as described in protocol technical manuals where the parameters 1...7 fields with default values are:

<b>1</b>	<b>2</b>	<b>3</b>	<b>4</b>	<b>5</b>	<b>6</b>	<b>7</b>
Mode	Power Step	Time Step	0x00	0x00	0x00	0x00
<b>0x00</b>	<b>0x01</b>	<b>0x0A</b>	<b>0x00</b>	<b>0x00</b>	<b>0x00</b>	<b>0x00</b>

Where:

Parameter	Description
Mode	Dynamic power management activation / deactivation in 'continuous' mode: <ul style="list-style-type: none"> <li>0x00: Off;</li> <li>0x01: Up, only increase power by power step every time step;</li> <li>0x02: Up / Down, increase power and then decrease it by power step every time step.</li> </ul>
Power Step	Power step: <ul style="list-style-type: none"> <li>0x01 ... 0x05 for power step in dB (1 ... 5 dB);</li> <li>0x81 ... 0xB2 for power step in mW x 10 (10 ... 500 mW).</li> </ul>
Time Step	Time step: <ul style="list-style-type: none"> <li>Decimal 1 ... 99 for time in ms x 100 (0.1 ... 9.9 seconds).</li> </ul>

### 3.2.5 RF Tuning



Only items 5224U, 5225U and 5226U with hardware version 2 and firmware version 2.xx integrates the reconfigurable RF carrier leakage canceler feature and support RF tuning configuration parameters!

Parameter	Description	Range	Default
Max Tune Steps	The maximum runtime RF tune steps. 0 to disable the runtime RF tuning.	0 ... 250	15
Max Tune Frequency Hops	The maximum RF frequency hops on the same RF frequency before RF tuning.	0 ... 250	15
Min Tune Frequency Hops	The minimum RF frequency hops on different RF frequency after RF tuning.	0 ... 250	15

Parameter	Description	Range	Default
Tune Hysteresis Index	The runtime RF tune hysteresis index of measured reflected power.	10% ... 50%	30%

The RF Tuning parameters are stored in configuration page nr. 0x0D and are managed through the 'Read RAM/ROM Configuration Parameters' and 'Write RAM/ROM Configuration Parameters' commands as described in protocol technical manuals where the parameters 1...7 fields with default values are:

1	2	3	4	5	6	7
Max Tune Steps	Max Tune Frequency Hops	Min Tune Frequency Hops	Tune Hysteresis Index	0x00	0x00	0x00
0x64	0x0F	0x0F	0x1E	0x00	0x00	0x00

Where:

Parameter	Description
Max Tune Steps	The maximum runtime RF tune steps. 0 to disable the runtime RF tuning.
Max Tune Frequency Hops	The maximum RF frequency hops on the same RF frequency before RF tuning.
Min Tune Frequency Hops	The minimum RF frequency hops on different RF frequency after RF tuning.
Tune Hysteresis Index	The runtime RF tune hysteresis index of measured reflected power.

### 3.3 Device Status

The information about the current status of the **BLUEBOX** shall be read with the 'Read Device Status' command as described in protocol technical manuals where the status bytes 1 and 2 have the following meaning.

Status Byte	Description
Status Byte 1	<p>Byte whose bits have the following meaning:</p> <ul style="list-style-type: none"> <li>• Bit 7: Not used</li> <li>• Bit 6: Not used;</li> <li>• Bit 5: RF status (0=off, 1=on)</li> <li>• Bit 4: 'Continuous' mode (1=enabled)</li> <li>• Bit 3: Not used</li> <li>• Bit 2: Not used</li> <li>• Bit 1: Not used</li> <li>• Bit 0: Not used</li> </ul>

Status Byte	Description
Status Byte 2	<p>Byte whose bits have the following meaning:</p> <ul style="list-style-type: none"> <li>• Bit 7: Not used</li> <li>• Bit 6: Not used</li> <li>• Bit 5: Not used</li> <li>• Bit 4: Solder jumper W1 (1=closed)</li> <li>• Bit 3: Not used</li> <li>• Bit 2: Not used</li> <li>• Bit 1: Not used</li> <li>• Bit 0: Not used</li> </ul>

## 4 Communication Features

The 'master/slave' protocol through the serial line (if available) expects that the **BLUEBOX** (as 'slave') after the reception of a message send to him by the 'host' (as 'master'), transmits a response message after a minimum time of about 10 ms. By default, the **BLUEBOX** will apply the following parameters: address 255, baud rate 19200, 8 data bits, parity none and 1 stop bit. These parameters can be modified as specified in the 'Parameters Programming' protocol command.

To simplify the explanations, the following conventions will be used:

SOH	Carattere 01h (0x01)
STX	Carattere 02h (0x02)
ETX	Carattere 03h (0x03)
EOT	Carattere 04h (0x04)
ENQ	Carattere 05h (0x05)
ACK	Carattere 06h (0x06)
NAK	Carattere 15h (0x15)
SYN	Carattere 16h (0x16)
CR	Carattere 0Dh (0x0D)
'0'...'9'	Carattere 30h ...39h (0x30 ... 0x39)
'A'...'F'	Carattere 41h ...46h (0x41 ... 0x46)
<..>	Carattere 30h ...39h (0x30 ... 0x39), 41h ...46h (0x41 ... 0x46)
<bcc>	Checksum

This is the general structure of a message:

**SOH <add h> <add l> ... <bcc> CR**

**SOH** is the opening character, **CR** is the final character, **<bcc>** is the checking character or checksum and it is calculated as 'xor' of the previous characters starting from SOH and applying the following rule: if **<bcc>** = SOH or **<bcc>** = CR or **<bcc>** = EOT , then **<bcc>** := **<bcc>**+1 (must be incremented of 1).

The **BLUEBOX** address is expressed with a byte (0...255 in decimal, 0x00 ... 0xFF in hexadecimal) transformed into two ASCII characters: the first ASCII character **<add h>** corresponds to the ASCII coding of the high nibble of the byte, while the second ASCII character **<add l>** corresponds to the ASCII coding of the low

nibble of the byte. Example: 255 → 0xFF → 'F' 'F'. This rule is also valid for coding a generic byte value.

For instance, the 'data request' command message for a **BLUEBOX** with address 1 will be: SOH '0' '1' ENQ ENQ CR (in hexadecimal: 0x01, 0x30, 0x31, 0x05, 0x05, 0x0D).

## 4.1 Device Startup

During the startup phase, it is possible to configure through the serial line (if available) the communication parameters of the **BLUEBOX** sending the following message (with the default communication settings 19200, n, 8, 1):

**STX '2' 'F' <addn h> <addn l> <bdr> <bit> <stop> <par> ETX <bcc> CR**

Where:

<b>&lt;add h&gt; &lt;add l&gt;</b>	New address to be set. ASCII encoded byte.
<b>&lt;bdr&gt;</b>	RS232/RS485 communication interface baud rate. ASCII character: <ul style="list-style-type: none"> <li>• '0' -&gt; 1200 bps;</li> <li>• '1' -&gt; 2400 bps;</li> <li>• '2' -&gt; 4800 bps;</li> <li>• '3' -&gt; 9600 bps;</li> <li>• '4' -&gt; 19200 bps;</li> <li>• '5' -&gt; 38400 bps;</li> <li>• '6' -&gt; 57600 bps;</li> <li>• '7' -&gt; 115200 bps.</li> </ul>
<b>&lt;bit&gt;</b>	RS232/RS485 communication interface data bits. ASCII character: <ul style="list-style-type: none"> <li>• '7' -&gt; 7 bits;</li> <li>• '8' -&gt; 8 bits.</li> </ul>
<b>&lt;stop&gt;</b>	RS232/RS485 communication interface stop bits. ASCII character: <ul style="list-style-type: none"> <li>• '1' -&gt; 1 bit;</li> <li>• '2' -&gt; 2 bits.</li> </ul>
<b>&lt;par&gt;</b>	RS232/RS485 communication interface parity. ASCII character: <ul style="list-style-type: none"> <li>• '0' -&gt; None;</li> <li>• '1' -&gt; Even;</li> <li>• '2' -&gt; Odd.</li> </ul>



<bcc>

Block check character or checksum calculated as 'xor' of the previous characters starting from STX applying the following rule: if <bcc> = STX or <bcc> = CR, then <bcc> := <bcc>+1 (increment of 1).

If the **BLUEBOX** is able to execute the command, it answers with:

**STX '2' 'F' '0' '0' <bcc> CR**

The 'BLUEBOX M30 Config' program is provided to explicate these operations.

## 5 'BLUEBOX M30 Config' Software

### 5.1 Software Startup

Double click on the 'BLUEBOX M30 Config' icon to start the software.



At software startup the following screenshot is shown

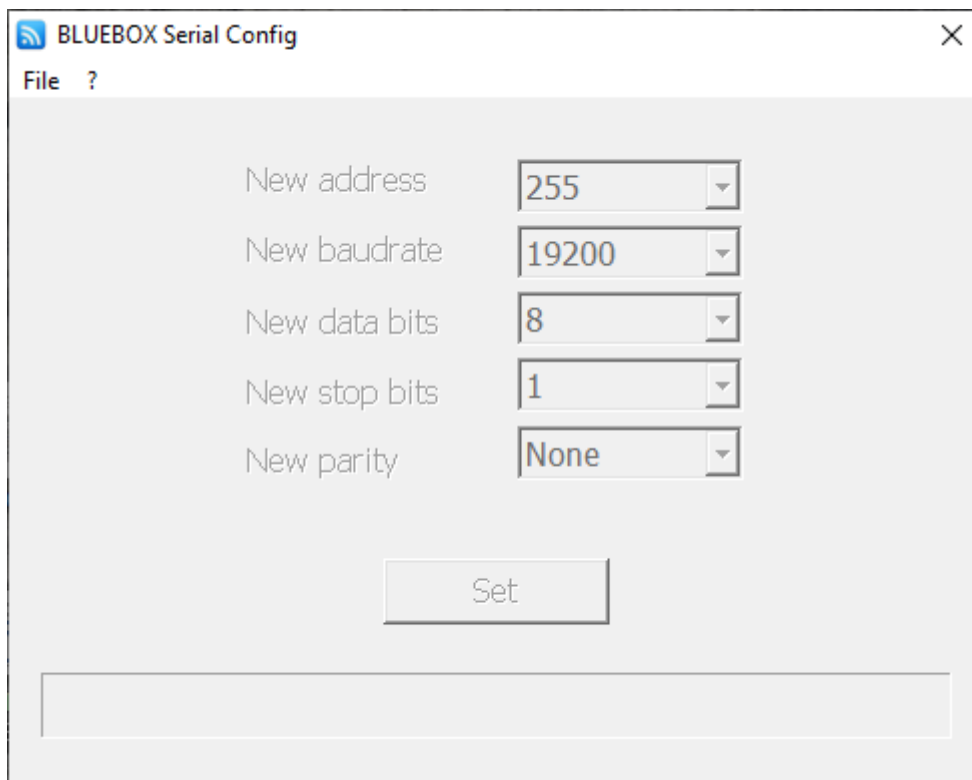

### 5.2 Menu

At the top of the software there is the menu bar.

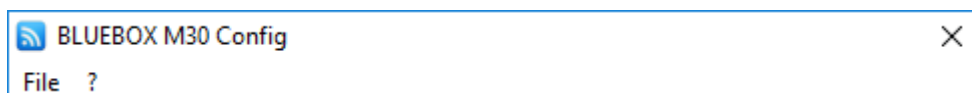

5.2.1 File Menu

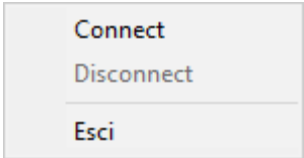

The File menu allows to select one of the following operations:

- Connect: to open the connection with the reader.

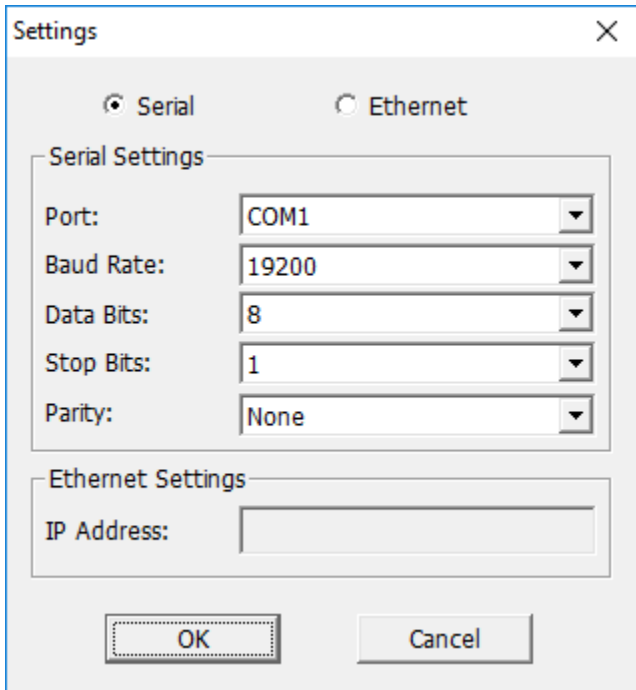

- Disconnect: to close the connection with the reader.
- Exit: to close the software.

5.2.2 Info Menu

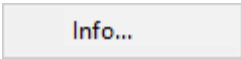

The Info menu allows to select one of the following operations:

- About: to show the software info.

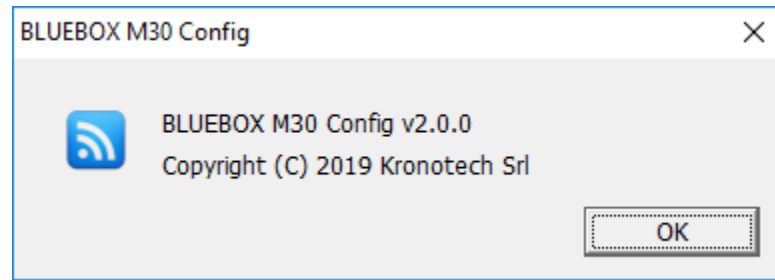

### 5.3 Software Usage

To set the communication parameters of the reader, first open the connection with the reader, then select the address to set from 0 to 255 and the serial settings and then click the Set button and power on the reader. A progress bar shows the communication progress. At the end a message box shows the status of the operation.

## 6 Installation

### 6.1 General Instructions

- Several devices installed next to each other interfere if they are not correctly configured.
- When mounting several nearby devices adhere to the minimum distances between them.
- Flush mounting of a device head in metal reduces the read and write distance.
- Keep the device away from direct sunlight, high humidity, extreme temperatures, and sources of electromagnetic interference. Any combination of these conditions might degrade performance or shorten the life of the device.
- Connect the device using a suitable cable as defined in electrical connections section.
- Power the device using a suitable external power supply as defined in electrical connections section. The boot sequence begins in either case when power is supplied to the device. This sequence typically completes within 5 seconds. After the boot sequence finishes, the device accepts commands, not before. The LED on the device alerts you to the status as defined in status indications section.

### 6.2 Notes on Tag Mounting

- For installation in and on metal tags provided for this purpose must be used.
- The tag must be placed in the reading area of the device antenna. The angle of aperture and the operating distance must be adhered to.
- The orientation of the device antenna axis must correspond with the axis of the tag for best performance.

### 6.3 Avoiding Interference

The device generates a modulated electrical field the UHF band 865 – 868 MHz. To avoid interference of the data communication no other devices generating interference emission in this frequency band must be operated in the vicinity.



Observe the notes on installation when several RFID UHF devices are operated simultaneously.

## 6.4 Mechanical Design

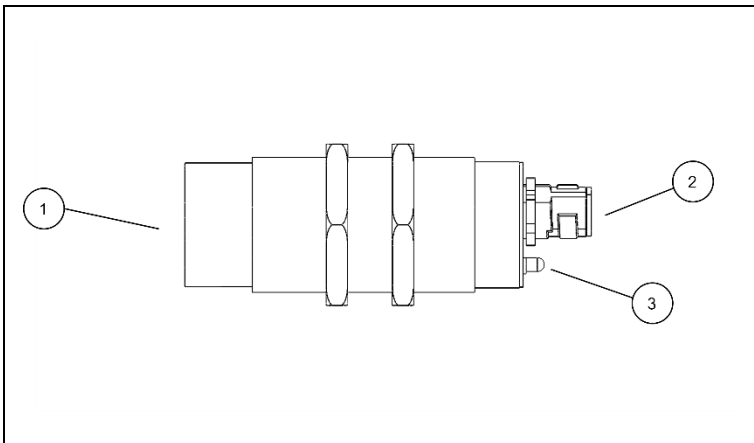

1. Sensing face (antenna)
2. Electrical connections
3. Status indications

## 6.5 Fixing

Fix the device using the supplied nuts (M30).

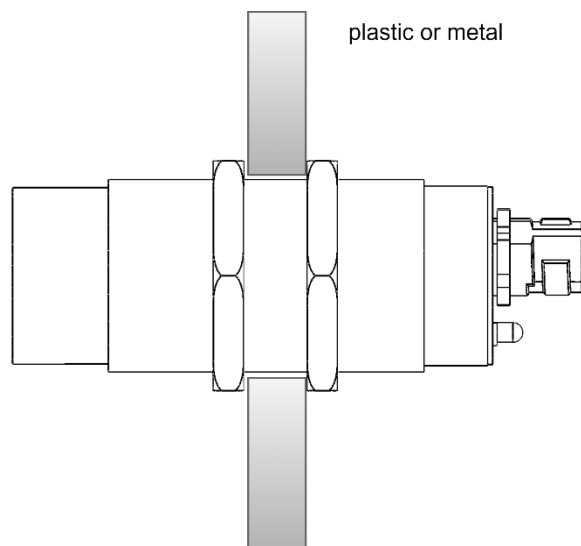

6.6 Mounting Distances

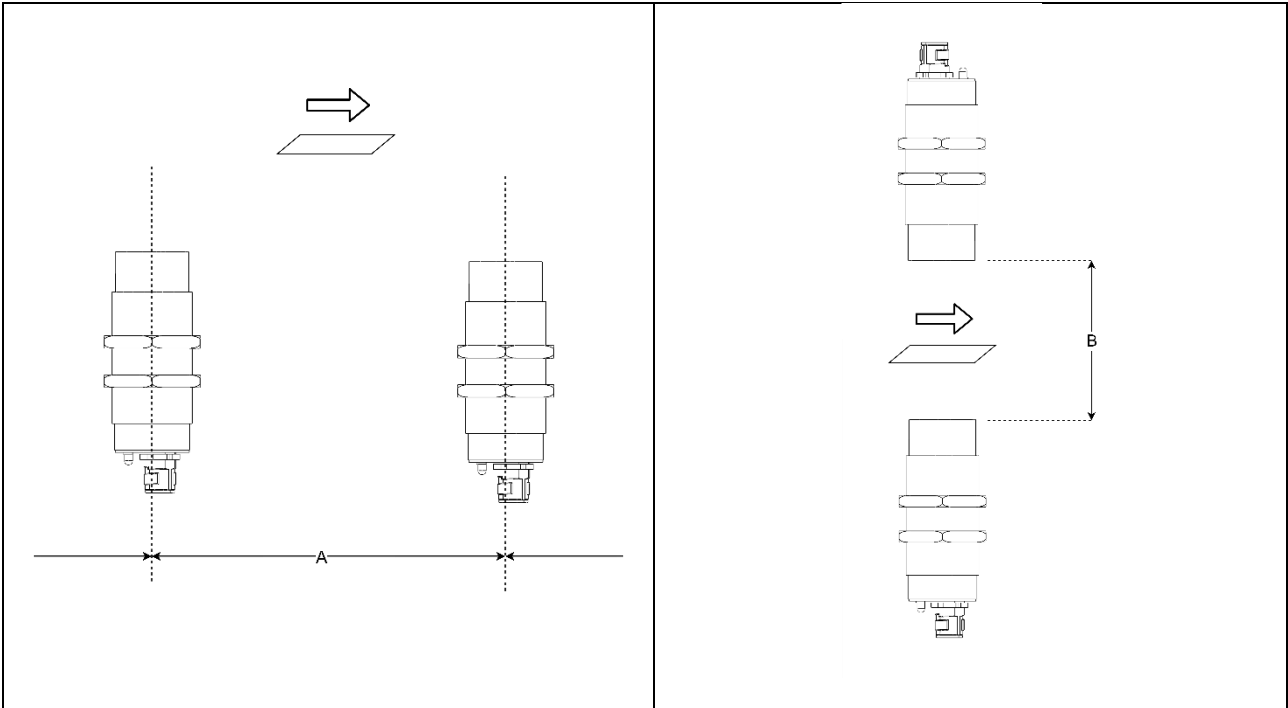

Operating Mode	Distance Side (A)	Distance Front (B)
Reading and writing at 100% transmitter power (simultaneous operation)	> 6.0mt	> 10.0mt
Reading and writing at 100% transmitter power (alternating operation)	> 0.3mt	> 0.3mt

6.7 Positioning of the Tags

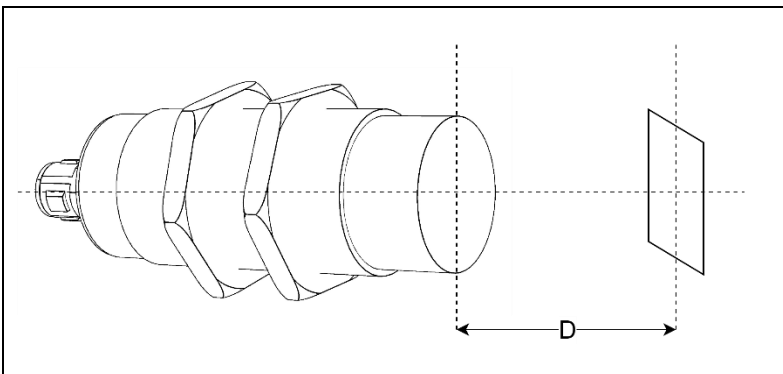

- Align the tag on the antenna central axis.
- See the tag datasheet for the distance D.

## 7 Electrical Connections

Observe the following instructions before electrical installation.

---



- The device must be connected by a skilled qualified person.
  - Device of protection class III.
  - Electric supply via SELV circuits only.
  - Disconnect power before connecting the device.
  - The IP rating indicated in the data sheet is only guaranteed if the M12 connectors are firmly screwed.
  - The device can be damaged by insufficiently tightened M12 connectors.
  - Screw the M12 connector to the device applying 1 to 1.5 Nm.
-



7.1 Electrical Connections 5224U

7.1.1 Power Supply and Serial Line

Connect the **BLUEBOX** to the voltage supply and serial interface using an M12 connection cable.

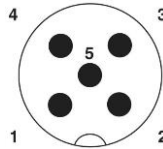

5-poles M12 A-coded male connector

Pin	No	Min	Typical	Max	Description
+PWR	1	10Vdc	12Vdc / 24Vdc	36Vdc	Positive DC power supply
RS232-Tx	2				RS232 Transmit (to host)
-PWR (GND)	3				DC power supply return (GND)
RS232-Rx	4				RS232 Receive (from host)
N.C.	5				Not Connected
SHIELD	-				Protected Earth



To ensure interference-free operation, the device must be connected to an earth potential free from external voltage.

Hereinafter a cross reference table between connection pin number and the color of the wires of a standard 5-poles cable with 5-poles M12 A-coded female connector and open ended cable.

Pin	No	Wire Cable Color
+PWR	1	Brown
RS232-Tx	2	White
-PWR (GND)	3	Blue
RS232-Rx	4	Black
N.C.	5	Grey

## 7.2 Electrical Connections 5225U

### 7.2.1 Power Supply and Serial Line

Connect the **BLUEBOX** to the voltage supply and serial interface using an M12 connection cable.

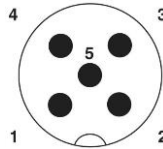

5-poles M12 A-coded male connector

Pin	No	Min	Typical	Max	Description
+PWR	1	10Vdc	12Vdc / 24Vdc	36Vdc	Positive DC power supply
RS485-RT+	2				RS485 connection (positive)
-PWR (GND)	3				DC power supply return (GND)
RS485-RT-	4				RS485 connection (negative)
N.C.	5				Not Connected
SHIELD	-				Protected Earth



To ensure interference-free operation, the device must be connected to an earth potential free from external voltage.

Hereinafter a cross reference table between connection pin number and the color of the wires of a standard 5-poles cable with 5-poles M12 A-coded female connector and open ended cable.

Pin	No	Wire Cable Color
+PWR	1	Brown
RS485-RT+	2	White
-PWR (GND)	3	Blue
RS485-RT-	4	Black
N.C.	5	Grey

7.3 Electrical Connections 5226U

7.3.1 Power Supply and CAN bus

Connect the **BLUEBOX** to the voltage supply and CAN bus using a suitable M12 CAN bus connection cable.

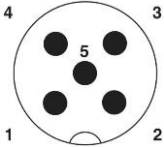

5-poles M12 A-coded male connector

Pin	No	Min	Typical	Max	Description
PE	1				Protected Earth
+ PWR	2	10Vdc	12/24Vdc	36Vdc	DC power supply
- PWR	3				DC power supply return path
CAN H	4				CAN bus connection (CAN H)
CAN L	5				CAN connection (CAN L)
SHIELD	-				Protected Earth



To ensure interference-free operation, the device must be connected to an earth potential free from external voltage.







Hereinafter a cross reference table between connection pin number and the color of the wires of a CAN bus 5-poles cable with 5-poles M12 A-coded female connector and open ended cable.

Pin	No	Wire Cable Color
PE	1	Shield
+ PWR	2	Red
- PWR	3	Black
CAN H	4	White
CAN L	5	Blue

## 8 Status Indications

The **BLUEBOX** uses one bicolor green/red LED. The following tables provides the indicator states and flash rates.

LED State	Description
On	The indicator is constantly on
Off	The indicator is constantly off
Blinking	The indicator turns on and off with a frequency of 2 Hz: on for 250 ms, followed by off for 250 ms
Slow Blink	The indicator turns on and off with a frequency of 1 Hz: on for 500 ms, followed by off for 500 ms

LED	Color	State	Meaning
<b>SYSTEM/TAG</b>	 (red)	On	<ul style="list-style-type: none"> <li>System error.</li> <li>System initialization.</li> <li>System upgrade.</li> </ul>
	 (yellow)	On	<ul style="list-style-type: none"> <li>System upgrade.</li> </ul>
	 (green)	Blinking	<ul style="list-style-type: none"> <li>Antenna active in 'continuous' mode, no tag detected.</li> </ul>
	 (green)	Slow Blink	<ul style="list-style-type: none"> <li>Antenna not active in 'continuous' mode.</li> <li>'Continuous' mode disabled.</li> </ul>
	 (green)	On	<ul style="list-style-type: none"> <li>Antenna active in 'continuous' mode, tag detected.</li> </ul>
	 (off)	Off	<ul style="list-style-type: none"> <li>Power supply for the device is missing.</li> <li>Hardware defect.</li> </ul>

## 9 Antenna

The **BLUEBOX** integrates an RF antenna inside the case.

The read range of an RFID system always depends on various factors like antenna size, transponder size, transponder IC type, orientation between transponder and reader antenna, position of the transponder versus the reader antenna, noise environment, metallic environment, etc. Therefore all data about read ranges can only be typical values measured under laboratory conditions. In real live applications the read range may differ from the data mentioned in the datasheet.

## 10 Maintenance, Repair and Disposal

If used correctly, no maintenance and repair measures are necessary

- The device must only be repaired by the manufacturer.
- After use dispose of the device in an environmentally friendly way in accordance with the applicable national regulations.
- Keep the device free from soiling.
- Do not open the device.

## 11 Regulatory Compliance

This section gives information on the **BLUEBOX** regulatory compliance.

### 11.1 CE Compliance

The **BLUEBOX** is in conformity with the relevant Union harmonisation legislation:

- **2014/53/EU** relating to the making available on the market of radio equipment
- **2014/30/EU** relating to electromagnetic compatibility
- **1999/519/EMC** on the limitation of exposure of the general public to electromagnetic fields

References to the relevant harmonised standards used or references to the other technical specifications in relation to which conformity is declared:

- Safety of Information Technology Equipment
  - EN 62368-1:2014 + AC:2015
- Limitation of human exposure to electromagnetic fields from devices operating in the frequency range 0 Hz to 300 GHz, used in Electronic Article Surveillance (EAS), Radio Frequency Identification (RFID) and similar applications
  - EN 50364:2010
- Electromagnetic Compatibility standard for radio equipment and services
  - EN 301 489-1 V1.9.2
  - EN 301 489-3 V1.6.1
- Radio Frequency Identification Equipment operating in the band 865 MHz to 868 MHz with power levels up to 2 W and in the band 915 MHz to 921 MHz with power levels up to 4 W
  - EN 302 208 V3.1.1
- Degrees of protection provided by enclosures (IP Code)
  - EN 60529:1992 + AC:1993 + A1:2000 + A2:2013

**12 Mechanical Drawings**

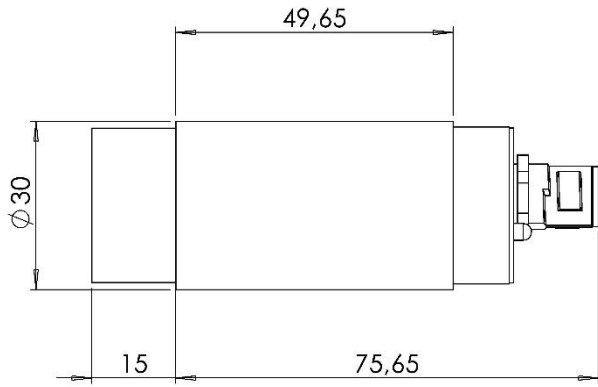

All the dimensions are in mm.



### 13 Document Revision History

Date	Revision	Description
26/09/16	1.00	First release.
06/10/16	1.01	Updated the firmware versions object of this manual. Added the 'Communication Features' section (section 4) with 'Device Startup' command (section 4.1). Added the 'BLUEBOX M30 Config Software' section (section 5).
24/11/16	1.02	Updated the reader's firmware versions object of this manual. Added the RF chip standby mode in RF parameters in section 3.1.2.
06/12/16	1.03	Updated the reader's firmware versions object of this manual. Added the ReadAfterDetect with custom info activation in EPC C1G2 parameters in section 3.1.2. Added the ReadAfterDetect with auto TID info activation in EPC C1G2 parameters in section 3.1.2. Added the search mode in EPC C1G2 parameters in section 3.1.2. Update the inventory mode range in EPC C1G2 parameters in section 3.1.2.
12/07/17	1.04	Updated the reader's firmware versions object of this manual. Fixed the technical protocol manuals. Added a warning to changed configuration parameters that become effective only after a device. Added the 640 kHz link frequency support. Added a table with allowed and DRM (Dense Reader Mode) link frequency and bit coding settings. Added a warning with the maximum supported ID length in bytes. Added the device status section.
08/06/18	1.05	Added CAN bus readers object of this manual in preface section. Updated the reader's firmware versions object of this manual in preface section.

Date	Revision	Description
		<p>Reduced the maximum RF power to 24dBm in technical specifications and RF parameters configuration description.</p> <p>Added CAN bus readers technical specifications.</p> <p>Added warnings in 'spontaneous' message management in operating features.</p> <p>Added the 'spontaneous' message activation on CAN bus interface description in operating features.</p> <p>Added the selection of CAN bus interface as 'spontaneous' message interface in 'spontaneous' message configuration.</p> <p>Added the RF sensitivity test, read reflected power and read RSSI test modes description in operating features section.</p> <p>Added the CAN bus interface configuration parameters description.</p> <p>Added CAN bus readers connection specifications.</p>
01/08/18	1.06	<p>Updated the reader's firmware versions object of this manual in preface section.</p> <p>Minor changes in operating features.</p> <p>Minor changes in general and configuration parameters.</p> <p>Added the RSSI info activation flag in RF configuration.</p>
12/09/18	1.07	<p>Updated the reader's firmware versions object of this manual in preface section.</p> <p>Minor changes in operating features.</p> <p>Minor changes in general and configuration parameters.</p> <p>Minor changes in status indications.</p> <p>Added the AFI management in EPC C1G2 configuration.</p>
16/10/18	1.08	<p>Updated the reader's firmware versions object of this manual in preface section.</p> <p>Added configuration for the "spontaneous" message format</p>
22/10/18	1.09	<p>Updated the reader's firmware versions object of this manual in preface section.</p> <p>Added the tag read count info activation flag in RF configuration.</p> <p>Corrections in operating features and configuration parameters.</p>
30/10/18	1.10	<p>Updated the reader's firmware versions object of this manual in preface section.</p>

Date	Revision	Description
		<p>Changed description in "spontaneous" message format field in spontaneous message configuration.</p> <p>Added ASCII mode setup for the "spontaneous" message format field in spontaneous message configuration.</p>
11/01/19	1.11	<p>Updated the company name/logo and BLUEBOX logo.</p> <p>Updated the reader's firmware versions object of this manual.</p> <p>Added the max RSSI info activation flag in RF configuration.</p>
01/02/19	1.12	<p>Updated the reader's firmware versions object of this manual.</p> <p>Added the Brazil RF region support in RF configuration and in regions of operation appendix.</p> <p>Minor changes and corrections in the configuration parameters.</p> <p>Moved the plans of frequencies from RF configuration section to regions of operations appendix.</p> <p>Moved the power requirements from antennas section to regions of operations appendix.</p>
05/02/19	1.13	<p>Move the tag data bytes limit warning from RF configuration parameters to operating features section.</p>
05/03/19	1.14	<p>Replaced BLUEBOX M30 Config software screenshots.</p>
02/09/19	1.15	<p>First release with hardware version 2 and firmware version 2.xx.</p> <p>Updated the reader's firmware versions object of this manual.</p> <p>Changes and document fixes in all sections.</p>
17/02/20	1.16	<p>Replaced ISO 18000-6C with ISO 18000-63. ISO 18000-6C became ISO 18000-63 in 2012 due to ISO naming rules that do not allow letters in standards names.</p> <p>Added the installation section.</p> <p>Added safety informations in electrical connections section.</p> <p>Added the maintenance, repair and disposal section.</p> <p>Added the regulatory compliance section.</p>
29/04/20	1.17	<p>Updated the reader's description object of this manual.</p> <p>Updated the reader's firmware versions object of this manual.</p> <p>Added the product identification system.</p>

Date	Revision	Description
		<p>Added the STX + dual char string format setup selection (STX + dual char string, STX + dual char string + CR, STX + dual char string + CRLF) in spontaneous message configuration parameters.</p> <p>Added the STX + ASCII string format setup selection (STX + ASCII string, STX + ASCII string + CR, STX + ASCII string + CRLF) in spontaneous message configuration parameters.</p> <p>Added the message encoding selection (None, Decimal) in spontaneous message configuration parameters.</p> <p>Replaced the 'BLUEBOX M30 Config' software with the "BLUEBOX Serial Config" one.</p> <p>Format changes and document fixes in all sections.</p>

## A. Regions of Operation

The **BLUEBOX** reader has been designed to work in various regions with differing frequency requirements. This document covers operation in North America, Brazil and Europe.

### A.1. Operation in Europe

For European operation, the **BLUEBOX** reader supports the frequency plan listed in the table below and is compliant with the ratified ETSI EN 302-208 specification V.3.1.0. This specification states that no listen-before-talk is performed, the maximum continuous transmit time on a channel is four seconds, and the reader enforces the 100 ms off time before reusing the same channel. In some applications (i.e. conveyor systems) it may be necessary for interrogators to transmit while tags are not present. To accommodate such requirements, the device shall include within interrogators a means to minimize the overall length of transmission commensurate with the application. This may include the provision of trigger mechanisms within interrogators to initiate transmissions.

RF Channel	Frequency [MHz]
4	865.7
7	866.3
10	866.9
14	867.5



According to ETSI EN 302208-1 only channels 4, 7, 10 and 13 (internal numerated as 1, 4, 7 and 10) could be used at high power! Other RF channels are present only for test purposes and should not be used in normal operation!

European regulations describe radiating power limits in relation to dipole antenna and ERP (Efficient Radiating Power) is used as a measure. The maximum RF output power is defined by the antenna gain, the half power beam width and the cable attenuation on the reader - antenna connection. For antennas with a half power beam width of up to 70° a power of  $P_{ERP,max} = 2W$  ERP is allowed. For other half power beam widths a reduced power of  $P_{ERP,max} = 0.5W$  ERP. The maximum **BLUEBOX** RF output power is defined as:

$$P_{C,max} = P_{ERP,max} - G_{IC} + 5.15 + C_L$$

Where:

$P_{C,max}$	Maximum RF output power in dBm
$P_{ERP,max}$	Maximum ERP power of the antenna in dBm
$G_{IC}$	Circular antenna gain in dBic
$C_L$	Cable loss in dB

A.2. Operation in North America

The FCC specifies frequency hopping across the North American spectrum allocated to UHF RFID (902–928 MHz, with hopping occurring between 902.75–927.25 MHz in 500 KHz steps). This specification states that no listen-before-talk is performed, the maximum continuous transmit time on a channel is 0.4 seconds.

RF Channel	Frequency [MHz]
1	902.75
2	903.25
3	903.75
...	...
49	926.75
50	927.25



Other RF channels and single channel selection are present only for test purposes and should not be used in normal operation!

FCC regulations describe the radiating power limits in relation to isotropic antenna and EIRP (Efficient Isotropic Radiating Power) is used as a measure. The maximum RF output power is defined by the antenna gain, the half power beam width and the cable attenuation on the reader - antenna connection. A power of  $P_{EIRP,max} = 36\text{dBm}$  EIRP subject to a maximum conducted power of allowance of 30dBm at the antenna connector is allowed. The maximum **BLUEBOX** RF output power is defined as:

$$P_{C,max} = P_{EIRP,max} - G_{IC} - 2.15 + 5.15 + C_L$$

Where:

$P_{C,max}$	Maximum RF output power in dBm
$P_{ERP,max}$	Maximum ERP power of the antenna in dBm
$G_{IC}$	Circular antenna gain in dBic
$C_L$	Cable loss in dB

### A.3. Operation in Brazil

The BLUEBOX operates over a subset of the FCC North American spectrum (902–928 MHz, with specific frequency and channel usage dictated by regulations of each country. Frequency hopping spread spectrum (FHSS) is used. No listen-before-talk is performed, the maximum continuous transmit time on a channel is 0.4 seconds.

RF Channel	Frequency [MHz]
1	902.75
2	903.25
3	903.75
4	904.25
5	904.75
6	905.25
7	905.75
8	906.25
9	906.75
10	907.25
26	915.25
27	915.75
28	916.25
29	916.75
30	917.25

RF Channel	Frequency [MHz]
31	917.75
32	918.25
33	918.75
34	919.25
35	919.75
36	920.25
37	920.75
38	921.25
39	921.75
40	922.25
41	922.75
42	923.25
43	923.75
44	924.25
45	924.75
46	925.25
47	925.75
48	926.25
49	926.75
50	927.25



Other RF channels and single channel selection are present only for test purposes and should not be used in normal operation!

Brazil regulations describe the radiating power limits in relation to isotropic antenna and EIRP (Efficient Isotropic Radiating Power) is used as a measure. The maximum RF output power is defined by the antenna gain, the half power beam width and the cable attenuation on the reader - antenna connection. A



power of  $P_{EIRP,max} = 36\text{dBm}$  EIRP subject to a maximum conducted power of allowance of  $30\text{dBm}$  at the antenna connector is allowed. The maximum **BLUEBOX** RF output power is defined as:

$$P_{C,max} = P_{EIRP,max} - G_{IC} - 2.15 + 5.15 + C_L$$

Where:

$P_{C,max}$	Maximum RF output power in dBm
$P_{ERP,max}$	Maximum ERP power of the antenna in dBm
$G_{IC}$	Circular antenna gain in dBic
$C_L$	Cable loss in dB

**B. RS232 DB9 to M12 Connection**

RS232 DB-9	
Pin	Description
2	RXD
3	TXD
5	GND

<-->  
<-->  
<-->

RS232 M12	
Pin	Description
2	TXD
4	RXD
3	GND