

# UHF RFID System

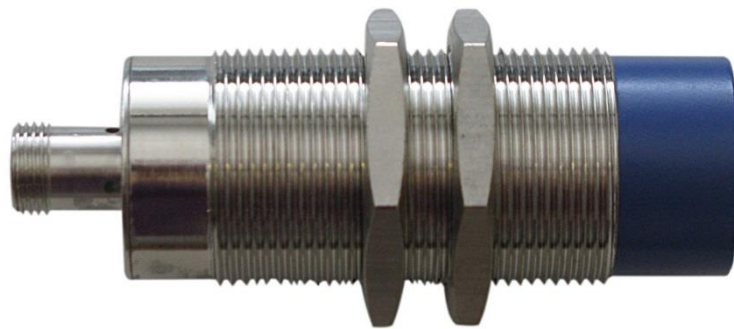

## M30 Form Factor BLUEBOX ADVANT UHF

**BLUEBOX**  
RFid System

## Preface

iDTRONIC GmbH (IDTRONIC) reserves the right to make changes to its products or services or to discontinue any product or service at any time without notice. IDTRONIC provides customer assistance in various technical areas, but, does not have full access to data concerning the use and applications of customer's products. Therefore, IDTRONIC assumes no liability and is not responsible for customer applications or product or software design or performance relating to systems or applications incorporating IDTRONIC products. In addition, IDTRONIC assumes no liability and is not responsible for infringement of patents and/or any other intellectual or industrial property rights of third parties, which may result from assistance provided by IDTRONIC. IDTRONIC products are not designed, intended, authorized or warranted to be suitable for life support applications or any other life critical applications that could involve potential risk of death, personal injury or severe property or environmental damage. With the edition of this document, all previous editions become void. Indications made in this manual may be changed without previous notice. Composition of the information in this manual has been done to the best of our knowledge. IDTRONIC does not guarantee the correctness and completeness of the details given in this manual and may not be held liable for damages ensuing from incorrect or incomplete information. Since, despite all our efforts, errors may not be completely avoided, we are always grateful for your useful tips. The installation instructions given in this manual are based on advantageous boundary conditions. IDTRONIC does not give any guarantee promise for perfect function in cross environments. The companies or products mentioned in this document might be brands or brand names of the different suppliers or their subsidiaries in any country. This document may be downloaded onto a computer, stored and duplicated as necessary to support the use of the related IDTRONIC products. Any other type of duplication, circulation or storage on data carriers in any manner not authorized by IDTRONIC represents a violation of the applicable copyright laws and shall be prosecuted.

iDTRONIC GmbH  
Donnersbergweg 1  
67059 Ludwigshafen  
Germany/Deutschland

Issue 1.06  
– 26. February 2020 –

Phone: +49 621 6690094-0  
Fax: +49 621 6690094-9  
E-Mail: [info@idtronic.de](mailto:info@idtronic.de)  
Web: [idtronic.de](http://idtronic.de)

Subject to alteration without prior notice.  
© Copyright iDTRONIC GmbH 2020  
Printed in Germany

**Safety Instructions / Warning - Read before start-up!**

- The device may only be used for the intended purpose designed by the manufacturer. The operation manual should be conveniently kept available at all times for each user.
- Unauthorized changes and the use of spare parts and additional devices that have not been sold or recommended by the manufacturer may cause fire, electric shocks or injuries. Such unauthorized measures shall exclude any liability by the manufacturer.
- The liability-prescriptions of the manufacturer in the issue valid at the time of purchase are valid for the device. The manufacturer shall not be held legally responsible for inaccuracies, errors, or omissions in the manual or automatically set parameters for a device or for an incorrect application of a device.
- Repairs may be executed by the manufacturer only.
- Only qualified personnel should carry out installation, operation, and maintenance procedures.
- Use of the device and its installation must be in accordance with national legal requirements and local electrical codes.
- When working on devices the valid safety regulations must be observed.



IP65



**This manual applies to the following devices:**

**Description:**

Read / write RFID UHF device with integrated antenna.  
CAN bus communication interface with CANopen protocol. EU (865 MHz ... 868MHz) version.

**Order Number:**

5227U



**This manual is valid as of firmware version:**

Order Number	Hardware Version	Firmware Version
5227U	1	1.54C
5227U	2	2.54C



Items 5227U with hardware version 1 and firmware version 1.xx are obsolete items and no long available!



Items 5227U with hardware version 1 and firmware version 1.xx could be upgraded only with firmware version 1.xx!



Items 5227U with hardware version 2 and firmware version 2.xx could be upgraded only with firmware version 2.xx!

**Table of Contents**

- 1 Introduction..... 6
- 2 Technical Specifications ..... 7
  - 2.1 Electrical Features..... 7
    - 2.1.1 Item 5227U..... 7
  - 2.2 Mechanical Features ..... 7
  - 2.3 Environmental Conditions..... 8
- 3 Operating Features ..... 9
  - 3.1 General Parameters.....10
  - 3.2 Configuration Parameters.....13
    - 3.2.1 CAN Bus Interface .....13
    - 3.2.2 RF and EPC C1G2 (Class-1 Generation-2).....13
    - 3.2.3 Dynamic Power Management .....30
    - 3.2.4 RF Tuning.....33
- 4 Installation .....37
  - 4.1 General Instructions .....37
  - 4.2 Notes on Tag Mounting .....37
  - 4.3 Avoiding Interference .....37
  - 4.4 Mechanical Design.....38
  - 4.5 Fixing .....38
  - 4.6 Mounting Distances .....39
  - 4.7 Positioning of the Tags.....39
- 5 Electrical Connections .....40
  - 5.1 Item 5227U.....40
- 6 Status Indications.....42
- 7 Antenna .....44
- 8 Maintenance, Repair and Disposal.....45
- 9 Regulatory Compliance.....46
  - 9.1 CE Compliance.....46
- 10 Mechanical Drawings.....47
- 11 Document Revision History .....48
- A. Regions of Operation.....50
  - A.1. Operation in Europe .....50
  - A.2. Operation in North America .....51
  - A.3. Operation in Brazil .....52

## 1 Introduction

The **BLUEBOX GEN2 M30 UHF** hereinafter named **BLUEBOX** is a little (dimensions of the cylindrical case D30 mm x 90.65 mm) read/write RFID device operating in the 840 MHz to 960 MHz frequency band and suitable for industrial application. The **BLUEBOX** communicates with a 'host' system (typically a PC or a PLC) through CAN bus communication interface with CANopen protocol (item 5227U) and acts as a joint through a set of commands between the host system and a RFID tag present near the antenna. Through the CAN bus, it is also possible to configure the functional parameters and to upgrade the firmware. The **BLUEBOX** is equipped with an integrated RF antenna inside the case and with a 5-poles M12 A-coded male connector.

## 2 Technical Specifications

This section provides details on the technical specifications of the **BLUEBOX**.

### 2.1 Electrical Features

This section provides details on the electrical features of the **BLUEBOX**.

#### 2.1.1 Item 5227U

Power Supply	10 ... 36 Vdc
Power Rating	4W@24dBm
Operating Frequency	865 MHz ... 868 MHz
RF Transmit Power	Max 0.25W (24dBm) conducted
RF Receive Sensitivity	Max -87dBm
Antenna	Integrated
Reading Distance	40cm <sup>1</sup>
Supported Transponders	ISO 18000-63 <sup>2</sup> (EPC Class-1 Gen-2 V2)
Communication Interface	CAN bus with CANopen protocol
Status Display	1 bicolor LED
Connections	5-poles M12 A-coded male connector

### 2.2 Mechanical Features

This section provides details on the mechanical features of the **BLUEBOX**.

Dimensions	M30 x 90.65 mm
Material	Nickelled brass, PC
Protection Class	IP65

<sup>1</sup> Reading distance depends on transponder type, antenna and environmental conditions.

<sup>2</sup> ISO 18000-6C became ISO 18000-63 in 2012 due to ISO naming rules that do not allow letters in standards names.

## 2.3 Environmental Conditions

This section provides details on the environmental conditions of the **BLUEBOX**.

Operating Temperature	-20°C ... +55°C
Storage Temperature	-40°C ... +85°C
Humidity	Up to 95%, non condensing



### 3 Operating Features

In 'continuous' mode the **BLUEBOX** is characterized by the coexistence of 2 'parallel' and asynchronous activities: the tag identification (inventory) and the communication with the 'host' system. The 'continuous' identification activity interacts with the communication activity through a buffer that contains the code of the last identified tags or that is empty indicating the absence of tags. Due to synchronization and filtering reasons, the buffer is handled for each identified tag by a parameter defined as 'hold time' (same as 'filter time' defined below, to be set in the range of 0 ... 99 seconds or 0 ... 99 minutes, default value 1 second) and allows to extend 'artificially' the presence of the tag after it leaves the antenna's influence area; this behavior is observable looking at the green led status that is 'on' indicating the presence of tag. Through the OD 2180h it is possible to get the data contained in the buffer.

The **BLUEBOX** handles also a 32 elements FIFO queue which is combined with the 'filter time' general parameter (to be set in a range of 0 ... 99 seconds or 0 ... 99 minutes, default value 1 second) that prevents the queue saturation in case of a tag 'continuous' presence. When a tag is identified, the **BLUEBOX** verifies if it belongs to the list of read tags. If the tag do not belong to the list (it is defined as 'new'), its code will be inserted in the queue, a filter time assigned to the tag will be started. Otherwise (the tag belong to the list of read tags), the **BLUEBOX** verifies if the relative filter time is expired. In this case (the filter time is expired), the tag is defined as 'new' and will be processed as described above, otherwise only the relative filter time will be rearmed. Through the OD 2181h and 2182h, it is possible to get the data contained in the queue and unload it.



Buffer and FIFO queue will hold onto a maximum of 82 bytes of tag data. Once the 82 bytes of tag data limit is reached, the exceeded bytes will be discarded!

The **BLUEBOX** allows the execution of 'on request' functions. During the execution of these functions, the 'continuous' identification activity will be suspended temporarily; the involved commands are relative to the read/write specific activities of the supported transponders.

If not required, the 'continuous' identification activity can be disabled through a flag defined in the parameters. In this case, the **BLUEBOX** will only execute the 'on request' commands already defined above.

'Test' modes are also defined:

- 'RF Power' test: allows the user to easily and quickly test the minimum RF output power needed to read a tag in a fixed position. The reader sweeps

from the minimum RF output power to maximum RF output power or until it finds a tag, increasing the RF power of 1 dB every 500ms with fixed Q selection algorithm and  $Q=0$ . It is an 'on request' function which temporarily suspends the 'continuous' mode.

- 'RF Sensitivity' test: allows the user to easily and quickly test the minimum RF input sensitivity needed to read a tag in a fixed position. The reader sweeps from the minimum RF input sensitivity to maximum RF input sensitivity or until it finds a tag, increasing the RF sensitivity of 1 dB every 500ms with fixed Q selection algorithm and  $Q=0$ . It is an 'on request' function which temporarily suspends the 'continuous' mode.
- Read Reflected Power: allows the user to read the reflected power of the antenna at a given frequency to check the antenna connection.
- Read RSSI: allows the user to read the signal strength received by the antenna at a given frequency to check the presence of external RF sources.

The **BLUEBOX** integrates a reconfigurable RF carrier leakage canceler feature which allows the usage of the reader in many different environments and configurations. The RF carrier leakage canceler adaption is done at every power on and during normal operations of the reader based on RF tuning configuration parameters described in next sections.



Only items 5227U with hardware version 2 and firmware version 2.xx integrates the reconfigurable RF carrier leakage canceler feature!

### 3.1 General Parameters

This section provides details on the configurable general parameters of the **BLUEBOX**.

The general parameters are managed through the OD 2200h.



The changed general parameters become effective only after a reset of the **BLUEBOX**. Reset the **BLUEBOX** using the 'Reset Device' command or via a hardware reset.

#### Value Definition:

Sub-index 00h contains the number of valid object entries within the record. The number of valid objects entries shall be the number of the general configuration parameters. Its value is 02h.

Sub-index 01h to 02h contains a configuration parameter. An attempt to change the value of the configuration parameter to any not supported value shall be responded with the SDO abort transfer service (abort code: 06090030h). See the **BLUEBOX** user manual for value definition details.

Parameter	Description	Range	Default
Filter Time	Reading and tag queue management filter time.  Note that 0 setting is internally overwritten with 1 second.	0 ... 99 sec 0 ... 99 min	1 sec
Reading Antenna Information	To add the reading antenna information in the tag's code.	Disabled Enabled	Disabled
Transponder Type Information	To add the transponder type information in the tag's code.	Disabled Enabled	Disabled
'Continuous' Mode	'Continuous' mode.	Disabled Enabled	Enabled

Sub-Index	Parameter	Description
01h	Filter Time	Reading and tag queue management filter time (0 setting is internally overwritten with 1 second): <ul style="list-style-type: none"> <li>Decimal 0 ... 99 for time in seconds (0 ... 99 seconds);</li> <li>Decimal 100 ... 199 for time in minutes (0 ... 99 minutes).</li> </ul>
02h	Functional Flags	Functional flags. Single bits are dedicated to disable (0 value) or enable (1 value) functions: <ul style="list-style-type: none"> <li>Bit 7: Not used;</li> <li>Bit 6: Not used;</li> <li>Bit 5: Reading antenna information in tag's code;</li> <li>Bit 4: Transponder type information in tag's code;</li> <li>Bit 3: Not used;</li> <li>Bit 2: Not used;</li> <li>Bit 1: Not used;</li> <li>Bit 0: 'Continuous' mode (0=enabled, 1=disabled).</li> </ul>

**Object Description:**

Index	2200h
Name	General configuration
Object Code	RECORD
Data Type	General configuration record

**Entry Description:**

Sub-Index	00h
Description	Number of parameters
Data Type	UNSIGNED8
Access	RO
PDO Mapping	No
Value Range	02h
Default Value	02h
Save Object	Yes

Sub-Index	01h
Description	Filter time
Data Type	UNSIGNED8
Access	RW
PDO Mapping	No
Value Range	See value definition
Default Value	01h
Save Object	Yes

Sub-Index	02h
Description	Functional flags
Data Type	UNSIGNED8
Access	RW
PDO Mapping	No
Value Range	See value definition
Default Value	00h
Save Object	Yes

## 3.2 Configuration Parameters

This section provides details on the configurable operational parameters of the **BLUEBOX**.

### 3.2.1 CAN Bus Interface

The CAN bus interface parameters are managed through OD 1014h, 1015h, 20F0h and 20F2h as described in protocol technical manual.



The changed CAN bus interface parameters become effective only after a reset of the **BLUEBOX**. Reset the **BLUEBOX** using the 'Reset Device' command or via a hardware reset.

### 3.2.2 RF and EPC C1G2 (Class-1 Generation-2)



This section provides details on the configurable RF and EPC C1G2 (Class-1 Generation-2) parameters of the **BLUEBOX**







The RF parameters are managed through the OD 2201h.



**Value Definition:**

Sub-index 00h contains the number of valid object entries within the record. The number of valid objects entries shall be the number of the general configuration parameters. Its value is 08h.

Sub-index 01h to 08h contains a configuration parameter. An attempt to change the value of the configuration parameter to any not supported value shall be responded with the SDO abort transfer service (abort code: 06090030h). See the **BLUEBOX** user manual for value definition details.

Parameter	Description	Range	Default
RF Geographical Region	RF geographical region.  Note that ETSI, FCC and Brazil readers cannot be altered and only operate per the regulatory laws in USA/Canada, the European Union and Brazil.	EU1: ETSI FCC: FCC BRA: Brazil	EU1: ETSI FCC: FCC BRA: Brazil
RF Transmit Power	RF conducted transmit power in dBm.  Refer to country specific regulations for limitations. You, the user, are responsible to ensure operation with the correct RF settings and are solely responsible for any fines and other	0 ... 24 dBm	20 dBm

Parameter	Description	Range	Default
	damages due to incorrect or non-compliant country/region settings.		
RF Receive Sensitivity	RF receive sensitivity in dBm.	-51 ... -87 dBm	-76 dBm
RF Channel	<p>RF channel.</p> <p> Note that 0 value stands for default settings of the selected region.</p> <p> Refer to country specific regulations for channel allocation within the band. You, the user, are responsible to ensure operation with the correct RF settings and are solely responsible for any fines and other damages due to incorrect or non-compliant country/region settings.</p>	<p>EU1: 0 ... 10</p> <p>FCC: 0 ... 50</p> <p>BRA: 0 ... 50</p>	0
Antenna 1 Activation	Activation of antenna 1.	Disabled Enabled	Enabled
RF Channel Allocation Time	<p>The maximum period of consecutive transmission on the same RF channel.</p> <p> Note that 0 value stands for default settings of the selected region.</p> <p> Refer to country specific regulations for limitations. You, the user, are responsible to ensure operation with the correct RF settings and are solely responsible for any fines and other damages due to incorrect or non-compliant country/region settings.</p>	<p>0.00 ... 0.99 seconds</p> <p>0 ... 99 seconds</p>	0
RF Channel Pause Time	<p>The minimum time between two consecutive transmissions in the same RF channel.</p> <p> Note that 0 value stands for default settings of the selected region.</p> <p> Refer to country specific regulations for limitations. You, the user, are responsible to ensure operation with the correct RF settings and are solely responsible for any fines and other damages due to incorrect or non-compliant country/region settings.</p>	<p>0.00 ... 0.99 seconds</p> <p>0 ... 99 seconds</p>	0
RF Chip Standby Mode	Activation / deactivation of the standby mode of the RF chip during RF off conditions to reduce power consumption and temperature increase.	Disabled Enabled	Enabled
RSSI Information	<p>The detection tag's signal RSSI I and Q measured values information.</p> <p> Note that this parameter become effective only after a reboot of the reader.</p>	Disabled Enabled	Disabled
Max RSSI Information	The detected tag's signal max RSSI I and Q measured values information.	Disabled Enabled	Disabled

Parameter	Description	Range	Default
	 Note that this parameter become effective only after a reboot of the reader.		
Tag Read Count Information	The tag read count information.  Note that this parameter become effective only after a reboot of the reader.	Disabled Enabled	Disabled

Sub-Index	Parameter	Description
01h	RF Geographical Region	RF geographical region: <ul style="list-style-type: none"> <li>• 0x01: North America (FCC compliant);</li> <li>• 0x02: Europe (ETSI compliant);</li> <li>• 0x03: Brazil (FCC subset compliant).</li> </ul>
02h	RF Transmit Power	RF conducted transmit power in the range 0 ... 24.
03h	RF Receive Sensitivity	Absolute value of the RF receive sensitivity in the range 51 ... 87.
04h	RF Channel	RF channel. Channel 0 stands for default settings of the selected region.
05h	RF Antennas Activation	A byte whose bits are dedicated to disable (0 value) or enable (1 value) the antennas to use: <ul style="list-style-type: none"> <li>• Bit 7: Not used.</li> <li>• Bit 6: Not used.</li> <li>• Bit 5: Not used.</li> <li>• Bit 4: Not used.</li> <li>• Bit 3: Not used.</li> <li>• Bit 2: Not used.</li> <li>• Bit 1: Not used.</li> <li>• Bit 0: Antenna 1.</li> </ul>
06h	RF Maximum Allocation Time	The maximum period of consecutive transmission on the same RF channel. 0 stands for default settings of the selected region. The allowed values are: <ul style="list-style-type: none"> <li>• Decimal 0 ... 99 for time in mseconds (0 ... 990 mseconds);</li> <li>• Decimal 100 ... 199 for time in seconds (0 ... 99 seconds).</li> </ul>
07h	RF Minimum Pause Time	The minimum time between two consecutive transmission in the same RF channel. 0 stands for default settings of the selected region. The allowed values are: <ul style="list-style-type: none"> <li>• Decimal 0 ... 99 for time in mseconds (0 ... 990 mseconds);</li> <li>• Decimal 100 ... 199 for time in seconds (0 ... 99 seconds).</li> </ul>
08h	RF Functional Flags	RF functional flags. Single bits are dedicated to disable (0 value) or enable (1 value) functions: <ul style="list-style-type: none"> <li>• Bit 7: Not used;</li> <li>• Bit 6: Not used</li> <li>• Bit 5: Not used;</li> </ul>

Sub-Index	Parameter	Description
		<ul style="list-style-type: none"> <li>• Bit 4: Not used;</li> <li>• Bit 3: Max RSSI information;</li> <li>• Bit 2: Tag read count information;</li> <li>• Bit 1: RSSI information;</li> <li>• Bit 0: RF chip standby mode (0=enabled, 1=disabled).</li> </ul>

**Object Description:**

Index	2201h
Name	RF configuration
Object Code	RECORD
Data Type	RF configuration record

**Entry Description:**

Sub-Index	00h
Description	Number of parameters
Data Type	UNSIGNED8
Access	RO
PDO Mapping	No
Value Range	08h
Default Value	08h
Save Object	Yes

Sub-Index	01h
Description	RF region
Data Type	UNSIGNED8
Access	RW
PDO Mapping	No
Value Range	See value definition
Default Value	See value definition
Save Object	Yes



Sub-Index	02h
Description	RF output power
Data Type	UNSIGNED8
Access	RW
PDO Mapping	No
Value Range	See value definition
Default Value	14h
Save Object	Yes

Sub-Index	03h
Description	RF input sensitivity
Data Type	UNSIGNED8
Access	RW
PDO Mapping	No
Value Range	See value definition
Default Value	4Ch
Save Object	Yes

Sub-Index	04h
Description	RF channel
Data Type	UNSIGNED8
Access	RW
PDO Mapping	No
Value Range	See value definition
Default Value	00h
Save Object	Yes

Sub-Index	05h
-----------	-----

Description	RF antenna activation
Data Type	UNSIGNED8
Access	RW
PDO Mapping	No
Value Range	See value definition
Default Value	01h
Save Object	Yes

Sub-Index	06h
Description	RF channel allocation time
Data Type	UNSIGNED8
Access	RW
PDO Mapping	No
Value Range	See value definition
Default Value	00h
Save Object	Yes

Sub-Index	07h
Description	RF channel pause time
Data Type	UNSIGNED8
Access	RW
PDO Mapping	No
Value Range	See value definition
Default Value	00h
Save Object	Yes

Sub-Index	08h
Description	RF functional flags
Data Type	UNSIGNED8

Access	RW
PDO Mapping	No
Value Range	See value definition
Default Value	00h
Save Object	Yes





The EPC C1G2 (Class-1 Generation-2) parameters are managed through the OD 2202h.



### Value Definition:

Sub-index 00h contains the number of valid object entries within the record. The number of valid objects entries shall be the number of the general configuration parameters. Its value is 13h.



Sub-index 01h to 13h contains a configuration parameter. An attempt to change the value of the configuration parameter to any not supported value shall be responded with the SDO abort transfer service (abort code: 06090030h). See the **BLUEBOX** user manual for value definition details.

Parameter	Description	Range	Default
Inventory Mode	How the reader does an inventory in 'continuous' mode.	Fast Multi Tag Fast Single Tag Standard Multi Tag Standard Single Tag	Standard Multi Tag
R->T Link Frequency	R->T Link Frequency as defined in EPC Class 1 Generation 2 protocol.	40 kHz 160 kHz 256 kHz 320 kHz 640 kHz	160 kHz
R->T Bit Coding	R->T Bit coding as defined in EPC Class 1 Generation 2 protocol.	FM0 Miller 2 Miller 4 Miller 8	Miller 2
Q Selection Algorithm	The Q selection algorithm used for setting the slot-counter parameter as defined in EPC Class 1 Generation 2 protocol.	Dynamic Fixed	Dynamic
Q Value	The Q value used in fixed Q selection algorithm or the starting Q value used in dynamic Q selection algorithm as defined in EPC Class 1 Generation 2 protocol.	0 ... 15	3

Parameter	Description	Range	Default
Q Initial	The minimum allowed Q value in dynamic Q algorithm mode.	0 ... 15	0
Q Final	The maximum allowed Q value in dynamic Q algorithm mode.	0 ... 15	4
Q Adjust Rounds	The maximum Q adjust rounds in dynamic Q algorithm mode.	0 ... 5	3
Inventory Cycles	The inventory cycles in inventory command.	0 ... 5	3
Search Mode	How the reader singulates (select) tags in 'continuous' mode.	Dual Target Single Target	Dual Target
Session	The session used as defined in EPC Class 1 Generation 2 protocol.	S0 S1 S2 S3	S0
Target	The target used as defined in EPC Class 1 Generation 2 protocol.	A B	A
EPC size	The size of the recognized EPC in bytes. 0 means all EPC sizes,	0 ... 62	0
ReadAfterDetect Activation	Activation of the ReadAfterDetect mode in 'continuous' mode.  Note that this parameter become effective only after a reboot of the reader.	None TID Custom	None
ReadAfterDetect Password	The password to be used to access to tag's memory in ReadAfterDetect mode (Inventory Mode = Standard Single/Multi Tag with Custom Info). Use a '0' password if the access password is not requested.  Note that this parameter become effective only after a reboot of the reader.	0x00 0x00 0x00 0x00 ... 0xFF 0xFF 0xFF 0xFF	0x00 0x00 0x00 0x00
ReadAfterDetect Bank	The tag's memory bank to access in ReadAfterDetect mode (Inventory Mode = Standard Single/Multi Tag with Custom Info).  Note that this parameter become effective only after a reboot of the reader.	Reserved TID EPC User	Reserved
ReadAfterDetect Address	The tag's memory start address to access in the specified memory bank in ReadAfterDetect mode (Inventory Mode = Standard Single/Multi Tag with Custom Info).  Note that this parameter become effective only after a reboot of the reader.	0x00 0x00 0x00 0x00 ... 0xFF 0xFF 0xFF 0xFF	0x00 0x00 0x00 0x00
ReadAfterDetect Length	The number of tag's memory blocks (2-bytes length) to access in the specified memory bank in ReadAfterDetect mode (Inventory Mode =	0 ... 255	0

Parameter	Description	Range	Default
	Standard Single/Multi Tag with Custom Info). In case of Reserved or User bank selected 0 means no tag's memory block access, in case of TID bank selected 0 means auto-length (class identifier, manufacturer identifier, serial number).  Note that this parameter become effective only after a reboot of the reader.		
ReadAfterDetect Info Flags	The tag's info (PC, EPC, CRC) to include in the tag's ID in ReadAfterDetect mode (Inventory Mode = Standard Single/Multi Tag with Custom Info).  Note that this parameter become effective only after a reboot of the reader.	PC, EPC, CRC	PC, EPC, CRC
Use AFI	To enable/disable the AFI (Application Family Identifier) management.	Disabled Enabled	Disabled
AFI	The AFI (Application Family Identifier) value.	0 ... 255	0

Sub-Index	Parameter	Description
01h	Inventory Mode	<p>A byte whose bits are dedicated to manage the inventory mode, the search mode and the ReadAfterDetect info activation parameters:</p> <ul style="list-style-type: none"> <li>• Bit 7: Not used.</li> <li>• Bit 6: Search mode (how the reader singulates tags in 'continuous' mode): <ul style="list-style-type: none"> <li>○ 0b: Dual Target (the reader singulates tags in both A and B states).</li> <li>○ 1b: Single Target (the reader singulates only tags that are in A state).</li> </ul> </li> <li>• Bit 5: Activation of the ReadAfterDetect with custom info as defined in ReadAfterDetect Password, Bank, Address, Length and EPC Info parameters (0b=OFF, 1b=ON).</li> <li>• Bit 4: Activation of the ReadAfterDetect with auto TID info (0b=OFF, 1b=ON).</li> <li>• Bit 3 ... bit 0: Inventory mode (how the reader does an inventory in 'continuous' mode): <ul style="list-style-type: none"> <li>○ 0x0: Fast Multi Tag: Inventory mode that does not take the tag to the Opened but to the Acknowledged state. This inventory mode is not as secure as the standard mode, but it is faster.</li> <li>○ 0x1: Fast Single Tag: The same inventory mode like the Fast Multi Tag, but with the slot count of 1. This has the effect that no anticollision procedure is performed.</li> <li>○ 0x2: Standard Multi Tag: Inventory mode like defined in the EPC C1G2 standard.</li> <li>○ 0x4: Standard Single Tag: The same inventory mode like the Standard Multi Tag, but with the slot count of 1. This has the effect that no anticollision procedure is performed.</li> </ul> </li> </ul>

Sub-Index	Parameter	Description																				
		<p> Note that allowed values are:</p> <table border="1"> <thead> <tr> <th>Inventory Mode</th> <th>ReadAfterDetect with Custom Info</th> <th>ReadAfterDetect with Auto TID</th> <th></th> </tr> </thead> <tbody> <tr> <td>Fast Multi Tag, Fast Single Tag</td> <td>Disabled</td> <td>Disabled</td> <td>Du</td> </tr> <tr> <td>Standard Multi Tag, Standard Single Tag</td> <td>Disabled</td> <td>Disabled</td> <td>Du</td> </tr> <tr> <td>Standard Multi Tag, Standard Single Tag</td> <td>Disabled</td> <td>Enabled</td> <td>Du</td> </tr> <tr> <td>Standard Multi Tag, Standard Single Tag</td> <td>Enabled</td> <td>Disabled</td> <td>Du</td> </tr> </tbody> </table>	Inventory Mode	ReadAfterDetect with Custom Info	ReadAfterDetect with Auto TID		Fast Multi Tag, Fast Single Tag	Disabled	Disabled	Du	Standard Multi Tag, Standard Single Tag	Disabled	Disabled	Du	Standard Multi Tag, Standard Single Tag	Disabled	Enabled	Du	Standard Multi Tag, Standard Single Tag	Enabled	Disabled	Du
Inventory Mode	ReadAfterDetect with Custom Info	ReadAfterDetect with Auto TID																				
Fast Multi Tag, Fast Single Tag	Disabled	Disabled	Du																			
Standard Multi Tag, Standard Single Tag	Disabled	Disabled	Du																			
Standard Multi Tag, Standard Single Tag	Disabled	Enabled	Du																			
Standard Multi Tag, Standard Single Tag	Enabled	Disabled	Du																			
02h	R->T Link Frequency	<p>R-&gt;T link frequency:</p> <ul style="list-style-type: none"> <li>• 0x00: 40 kHz;</li> <li>• 0x02: 160 kHz;</li> <li>• 0x04: 256 kHz;</li> <li>• 0x05: 320 kHz;</li> <li>• 0x06: 640 kHz.</li> </ul>																				
03h	R->T Bit Coding	<p>R-&gt;T bit coding:</p> <ul style="list-style-type: none"> <li>• 0x00: FM0;</li> <li>• 0x01: Miller 2;</li> <li>• 0x02: Milller 4;</li> <li>• 0x03: Miller 8.</li> </ul> <p> Note that allowed values are:</p> <table border="1"> <thead> <tr> <th>Link Frequency</th> <th>Bit Coding</th> </tr> </thead> <tbody> <tr> <td>40 kHz</td> <td>FM0, Miller 2, Miller 4, Miller 8</td> </tr> <tr> <td>160 kHz</td> <td>FM0, Miller 2, Miller 4, Miller 8</td> </tr> <tr> <td>256 kHz</td> <td>Miller 4, Miller 8</td> </tr> <tr> <td>320 kHz</td> <td>Miller 4, Miller 8</td> </tr> <tr> <td>640 kHz</td> <td>Miller 4, Miller 8</td> </tr> </tbody> </table> <p> DRM (Dense Reader Mode):</p> <table border="1"> <thead> <tr> <th>Link Frequency</th> <th>Bit Coding</th> </tr> </thead> <tbody> <tr> <td>256 kHz</td> <td>Miller 4, Miller 8</td> </tr> <tr> <td>320 kHz</td> <td>Miller 4, Miller 8</td> </tr> </tbody> </table>	Link Frequency	Bit Coding	40 kHz	FM0, Miller 2, Miller 4, Miller 8	160 kHz	FM0, Miller 2, Miller 4, Miller 8	256 kHz	Miller 4, Miller 8	320 kHz	Miller 4, Miller 8	640 kHz	Miller 4, Miller 8	Link Frequency	Bit Coding	256 kHz	Miller 4, Miller 8	320 kHz	Miller 4, Miller 8		
Link Frequency	Bit Coding																					
40 kHz	FM0, Miller 2, Miller 4, Miller 8																					
160 kHz	FM0, Miller 2, Miller 4, Miller 8																					
256 kHz	Miller 4, Miller 8																					
320 kHz	Miller 4, Miller 8																					
640 kHz	Miller 4, Miller 8																					
Link Frequency	Bit Coding																					
256 kHz	Miller 4, Miller 8																					
320 kHz	Miller 4, Miller 8																					
04h	Q Selection Algorithm	<p>The Q selection algorithm used for setting the slot-counter parameter as defined in EPC Class 1 Generation 2 protocol:</p> <ul style="list-style-type: none"> <li>• 0x00: Dynamic</li> <li>• 0x01: Fixed</li> </ul>																				

Sub-Index	Parameter	Description
05h	Q Value	The Q value used in fixed Q selection algorithm or the starting Q value used in dynamic Q selection algorithm as defined in EPC Class 1 Generation 2 protocol (0 ... 15).
06h	Q Initial	The minimum allowed Q value in dynamic Q selection algorithm mode (0 ... 15)
07h	Q Final	The maximum allowed Q value in dynamic Q selection algorithm mode (0 ... 15)
08h	Q Adjust Rounds	The maximum Q adjust rounds in dynamic Q selection algorithm mode (0 ... 5)
09h	Inventory Cycles	The inventory cycles in inventory command (0 ... 5).
0Ah	Session	The session used as defined in EPC Class 1 Generation 2 protocol: <ul style="list-style-type: none"> <li>• 0x00: S0</li> <li>• 0x01: S1</li> <li>• 0x02: S2</li> <li>• 0x03: S3</li> </ul>
0Bh	Target	The target used as defined in EPC Class 1 Generation 2 protocol: <ul style="list-style-type: none"> <li>• 0x00: A</li> <li>• 0x01: B</li> </ul>
0Ch	EPC size	The size of the recognized EPC in bytes. 0, 2, 4, ... 62. 0 means all EPC sizes.
0Dh	ReadAfterDetect Password	The password to be used to access to tag's memory in ReadAfterDetect mode (Inventory Mode = Standard Single/Multi Tag with Custom Info). Use a '0' password if the access password is not requested.
0Eh	ReadAfterDetect Bank	The tag's memory bank to access in ReadAfterDetect mode (Inventory Mode = Standard Single/Multi Tag with Custom Info): <ul style="list-style-type: none"> <li>• 0x00: Reserved</li> <li>• 0x01: EPC</li> <li>• 0x02: TID</li> <li>• 0x03: User</li> </ul>
0Fh	ReadAfterDetect Address	The tag's memory start address to access in the specified memory bank in ReadAfterDetect mode (Inventory Mode = Standard Single/Multi Tag with Custom Info).
10h	ReadAfterDetect Length	The number of tag's memory blocks (2-bytes length) to access in the specified memory bank in ReadAfterDetect mode (Inventory Mode = Standard Single/Multi Tag with Custom Info). In case of Reserved or User bank selected 0 means no tag's memory block access, in case of TID bank selected 0 means auto-length (class identifier, manufacturer identifier, serial number).
11h	ReadAfterDetect Flags	The tag's info (PC, EPC, CRC) to include in the tag's ID in ReadAfterDetect mode (Inventory Mode = Standard Single/Multi Tag with Custom Info). A byte whose bits are dedicated to disable (0 value) or enable (1 value) functions:

Sub-Index	Parameter	Description
		<ul style="list-style-type: none"> <li>• Bit 7: Not used;</li> <li>• Bit 6: Not used;</li> <li>• Bit 5: Not used;</li> <li>• Bit 4: Not used;</li> <li>• Bit 3: Not used;</li> <li>• Bit 2: CRC field;</li> <li>• Bit 1: EPC field;</li> <li>• Bit 0: PC field.</li> </ul>
12h	Use AFI	AFI management activation/deactivation: <ul style="list-style-type: none"> <li>• 0x00: Disabled;</li> <li>• 0x01: Enabled.</li> </ul>
13h	AFI	The AFI value.

**Object Description:**

Index	2202h
Name	EPC Class-1 Generation-2 configuration
Object Code	RECORD
Data Type	EPC Class-1 Generation-2 configuration record

**Entry Description:**

Sub-Index	00h
Description	Number of parameters
Data Type	UNSIGNED8
Access	RO
PDO Mapping	No
Value Range	13h
Default Value	13h
Save Object	Yes

Sub-Index	01h
Description	Inventory mode
Data Type	UNSIGNED8
Access	RW



PDO Mapping	No
Value Range	See value definition
Default Value	02h
Save Object	Yes

Sub-Index	02h
Description	R->T link frequency
Data Type	UNSIGNED8
Access	RW
PDO Mapping	No
Value Range	See value definition
Default Value	02h
Save Object	Yes

Sub-Index	03h
Description	R->T bit coding
Data Type	UNSIGNED8
Access	RW
PDO Mapping	No
Value Range	See value definition
Default Value	01h
Save Object	Yes

Sub-Index	04h
Description	Q algorithm
Data Type	UNSIGNED8
Access	RW
PDO Mapping	No
Value Range	See value definition

Default Value	00h
Save Object	Yes

Sub-Index	05h
Description	Q value
Data Type	UNSIGNED8
Access	RW
PDO Mapping	No
Value Range	See value definition
Default Value	03h
Save Object	Yes

Sub-Index	06h
Description	Q initial
Data Type	UNSIGNED8
Access	RW
PDO Mapping	No
Value Range	See value definition
Default Value	00h
Save Object	Yes

Sub-Index	07h
Description	Q final
Data Type	UNSIGNED8
Access	RW
PDO Mapping	No
Value Range	See value definition
Default Value	04h

Save Object	Yes
Sub-Index	08h
Description	Q adjust rounds
Data Type	UNSIGNED8
Access	RW
PDO Mapping	No
Value Range	See value definition
Default Value	03h
Save Object	Yes
Sub-Index	09h
Description	Inventory cycles
Data Type	UNSIGNED8
Access	RW
PDO Mapping	No
Value Range	See value definition
Default Value	03h
Save Object	Yes
Sub-Index	0Ah
Description	Session
Data Type	UNSIGNED8
Access	RW
PDO Mapping	No
Value Range	See value definition
Default Value	00h
Save Object	Yes

Sub-Index	0Bh
Description	Target
Data Type	UNSIGNED8
Access	RW
PDO Mapping	No
Value Range	See value definition
Default Value	00h
Save Object	Yes

Sub-Index	0Ch
Description	EPC size
Data Type	UNSIGNED8
Access	RW
PDO Mapping	No
Value Range	See value definition
Default Value	00h
Save Object	Yes

Sub-Index	0Dh
Description	ReadAfterDetect password
Data Type	UNSIGNED32
Access	RW
PDO Mapping	No
Value Range	UNSIGNED32
Default Value	00000000h
Save Object	Yes

Sub-Index	0Eh
-----------	-----

Description	ReadAfterDetect bank
Data Type	UNSIGNED8
Access	RW
PDO Mapping	No
Value Range	See value definition
Default Value	00h
Save Object	Yes

Sub-Index	0Fh
Description	ReadAfterDetect address
Data Type	UNSIGNED32
Access	RW
PDO Mapping	No
Value Range	UNSIGNED32
Default Value	00000000h
Save Object	Yes

Sub-Index	10h
Description	ReadAfterDetect length
Data Type	UNSIGNED8
Access	RW
PDO Mapping	No
Value Range	UNSIGNED8
Default Value	00h
Save Object	Yes

Sub-Index	11h
Description	ReadAfterDetect flags
Data Type	UNSIGNED8

Access	RW
PDO Mapping	No
Value Range	See value definition
Default Value	07h
Save Object	Yes

Sub-Index	12h
Description	Use AFI
Data Type	UNSIGNED8
Access	RW
PDO Mapping	No
Value Range	See value definition
Default Value	00h
Save Object	Yes

Sub-Index	13h
Description	AFI
Data Type	UNSIGNED8
Access	RW
PDO Mapping	No
Value Range	UNSIGNED8
Default Value	00h
Save Object	Yes

### 3.2.3 Dynamic Power Management



This section provides details on the configurable dynamic power management parameters of the **BLUEBOX**

The dynamic power management parameters are managed through the OD 2203h.

**Value Definition:**

Sub-index 00h contains the number of valid object entries within the record. The number of valid objects entries shall be the number of the general configuration parameters. Its value is 03h.

Sub-index 01h to 03h contains a configuration parameter. An attempt to change the value of the configuration parameter to any not supported value shall be responded with the SDO abort transfer service (abort code: 06090030h). See the **BLUEBOX** user manual for value definition details.

Parameter	Description	Range	Default
Mode	How the reader manages the power in 'continuous' mode.  Note that this parameter become effective only after a reboot of the reader.	Off Up Up/down	Off
Power Step	The power step in dynamic power management mode activated.  Note that this parameter become effective only after a reboot of the reader.	1 ... 5 dB 10 ... 500 mW	1 dB
Time Step	The time step in dynamic power management mode activated.  Note that this parameter become effective only after a reboot of the reader.	0.1 ... 9.9 seconds	1.0 sec

Sub-Index	Parameter	Description
01h	Mode	How the reader manages the power in 'continuous' mode: <ul style="list-style-type: none"> <li>• 0x00: Off;</li> <li>• 0x01: Up, only increase power by power step every time step;</li> <li>• 0x02: Up / Down, increase power and then decrease it by power step every time step.</li> </ul>
02h	Power Step	The power step in dynamic power management mode activated: <ul style="list-style-type: none"> <li>• 0x01 ... 0x05 for power step in dB (1 ... 5 dB);</li> <li>• 0x81 ... 0xB2 for power step in mW x 10 (10 ... 500 mW).</li> </ul>
03h	Time Step	The time step in dynamic power management mode activated: <ul style="list-style-type: none"> <li>• Decimal 1 ... 99 for time in ms x 100 (0.1 ... 9.9 seconds).</li> </ul>

**Object Description:**

Index	2203h
Name	Dynamic power configuration

Object Code	RECORD
-------------	--------

Data Type	Dynamic power configuration record
-----------	------------------------------------

**Entry Description:**

Sub-Index	00h
-----------	-----

Description	Number of parameters
-------------	----------------------

Data Type	UNSIGNED8
-----------	-----------

Access	RO
--------	----

PDO Mapping	No
-------------	----

Value Range	03h
-------------	-----

Default Value	03h
---------------	-----

Save Object	Yes
-------------	-----

Sub-Index	01h
-----------	-----

Description	Mode
-------------	------

Data Type	UNSIGNED8
-----------	-----------

Access	RW
--------	----

PDO Mapping	No
-------------	----

Value Range	See value definition
-------------	----------------------

Default Value	00h
---------------	-----

Save Object	Yes
-------------	-----

Sub-Index	02h
-----------	-----

Description	Power step
-------------	------------

Data Type	UNSIGNED8
-----------	-----------

Access	RW
--------	----

PDO Mapping	No
-------------	----

Value Range	See value definition
-------------	----------------------

Default Value	01h
---------------	-----



Save Object	Yes
Sub-Index	03h
Description	Time step
Data Type	UNSIGNED8
Access	RW
PDO Mapping	No
Value Range	See value definition
Default Value	05h
Save Object	Yes

### 3.2.4 RF Tuning

This section provides details on the configurable dynamic power management parameters of the **BLUEBOX**



Only items 5227U with hardware version 2 and firmware version 2.xx integrates the reconfigurable RF carrier leakage canceler feature and support RF tuning configuration parameters!

The dynamic power management parameters are managed through the OD 2204h.

#### Value Definition:

Sub-index 00h contains the number of valid object entries within the record. The number of valid objects entries shall be the number of the general configuration parameters. Its value is 04h.

Sub-index 01h to 04h contains a configuration parameter. An attempt to change the value of the configuration parameter to any not supported value shall be responded with the SDO abort transfer service (abort code: 06090030h). See the **BLUEBOX** user manual for value definition details.

Parameter	Description	Range	Default
Max Tune Steps	The maximum runtime RF tune steps. 0 to disable the runtime RF tuning.	0 ... 250	15

Parameter	Description	Range	Default
Max Tune Frequency Hops	The maximum RF frequency hops on the same RF frequency before RF tuning.	0 ... 250	15
Min Tune Frequency Hops	The minimum RF frequency hops on different RF frequency after RF tuning.	0 ... 250	15
Tune Hysteresis Index	The runtime RF tune hysteresis index of measured reflected power.	10% ... 50%	30%

Sub-Index	Parameter	Description
01h	Max Tune Steps	The maximum runtime RF tune steps. 0 to disable the runtime RF tuning.
02h	Max Tune Frequency Hops	The maximum RF frequency hops on the same RF frequency before RF tuning.
03h	Min Tune Frequency Hops	The minimum RF frequency hops on different RF frequency after RF tuning.
04h	Tune Hysteresis Index	The runtime RF tune hysteresis index of measured reflected power.

### Object Description:

Index	2204h
Name	RF tuning configuration
Object Code	RECORD
Data Type	RF tuning configuration record

### Entry Description:

Sub-Index	00h
Description	Number of parameters
Data Type	UNSIGNED8
Access	RO
PDO Mapping	No
Value Range	04h

Default Value	04h
Save Object	Yes

Sub-Index	01h
Description	Max Tune Steps
Data Type	UNSIGNED8
Access	RW
PDO Mapping	No
Value Range	See value definition
Default Value	64h
Save Object	Yes

Sub-Index	02h
Description	Max Tune Frequency Hops
Data Type	UNSIGNED8
Access	RW
PDO Mapping	No
Value Range	See value definition
Default Value	0Fh
Save Object	Yes

Sub-Index	03h
Description	Min Tune Frequency Hops
Data Type	UNSIGNED8
Access	RW
PDO Mapping	No
Value Range	See value definition
Default Value	0Fh

Save Object	Yes
Sub-Index	04h
Description	Tune Hysteresis Index
Data Type	UNSIGNED8
Access	RW
PDO Mapping	No
Value Range	See value definition
Default Value	1Eh
Save Object	Yes

## 4 Installation

This section provides details on the installation of the **BLUEBOX**.

### 4.1 General Instructions

- Several devices installed next to each other interfere if they are not correctly configured.
- When mounting several nearby devices adhere to the minimum distances between them.
- Flush mounting of a device head in metal reduces the read and write distance.
- Keep the device away from direct sunlight, high humidity, extreme temperatures, and sources of electromagnetic interference. Any combination of these conditions might degrade performance or shorten the life of the device.
- Connect the device using a suitable cable as defined in electrical connections section.
- Power the device using a suitable external power supply as defined in electrical connections section. The boot sequence begins in either case when power is supplied to the device. This sequence typically completes within 5 seconds. After the boot sequence finishes, the device accepts commands, not before. The LED on the device alerts you to the status as defined in status indications section.

### 4.2 Notes on Tag Mounting

- For installation in and on metal tags provided for this purpose must be used.
- The tag must be placed in the reading area of the device antenna. The angle of aperture and the operating distance must be adhered to.
- The orientation of the device antenna axis must correspond with the axis of the tag for best performance.

### 4.3 Avoiding Interference

The device generates a modulated electrical field the UHF band 865 – 868 MHz. To avoid interference of the data communication no other devices generating interference emission in this frequency band must be operated in the vicinity.



Observe the notes on installation when several RFID UHF devices are operated simultaneously.

#### 4.4 Mechanical Design

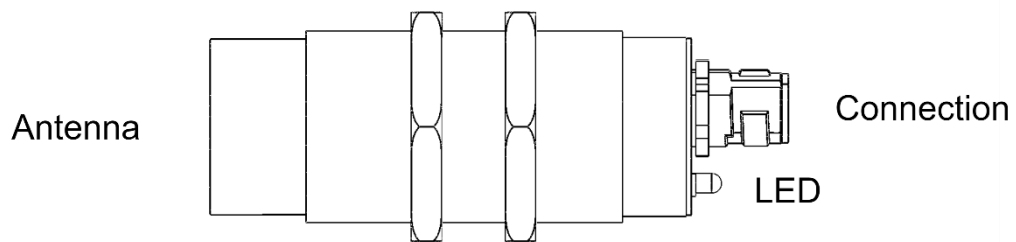

#### 4.5 Fixing

Fix the device using the supplied nuts (M30)

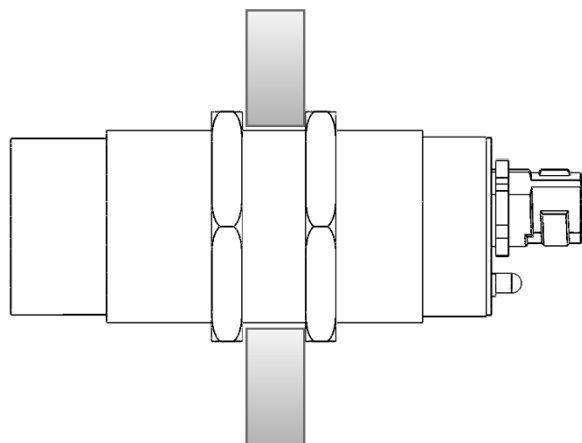

### 4.6 Mounting Distances

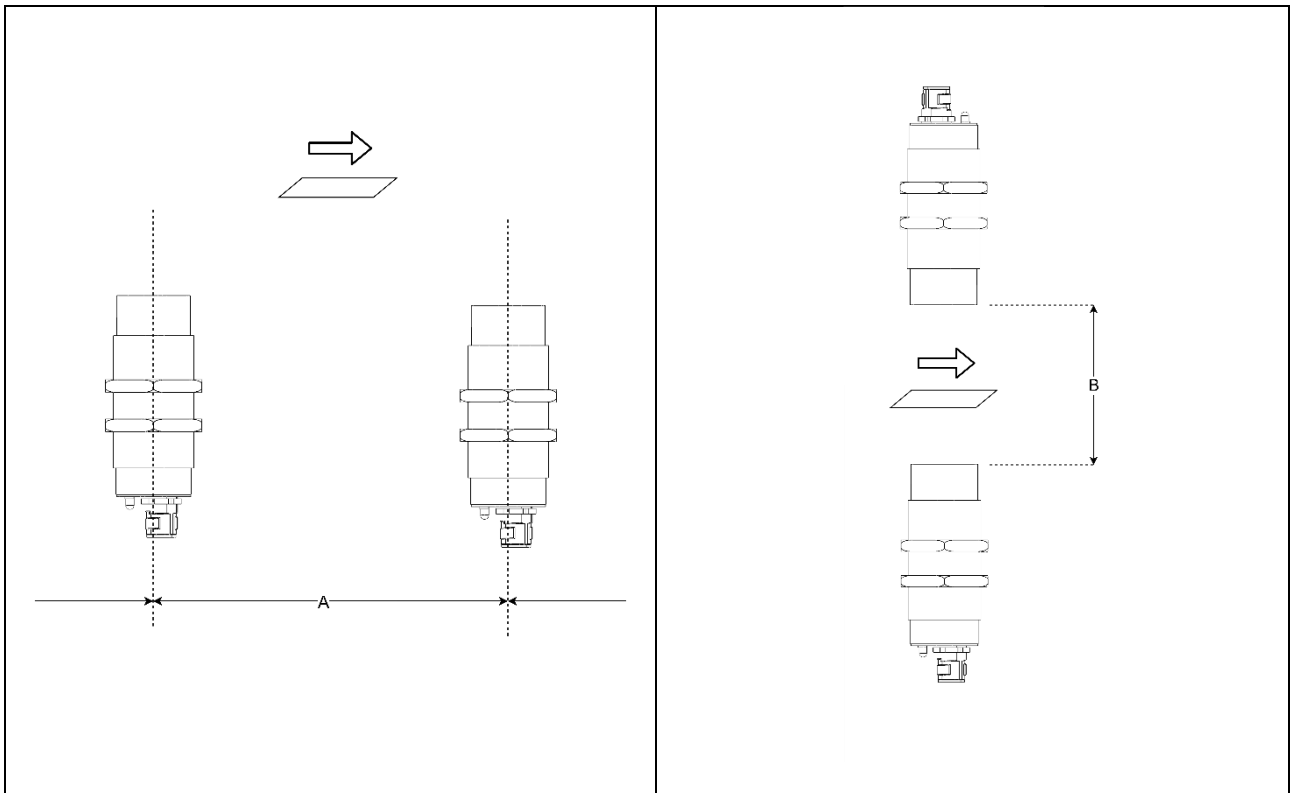

Operating Mode	Distance Side (A)	Distance Front (B)
Reading and writing at 100% transmitter power (simultaneous operation)	> 6.0mt	> 10.0mt
Reading and writing at 100% transmitter power (alternating operation)	> 0.3mt	> 0.3mt

### 4.7 Positioning of the Tags

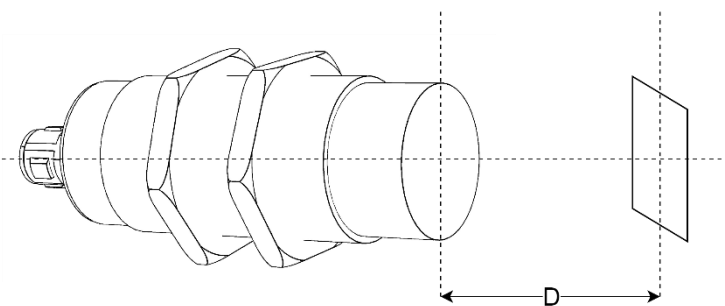

- Align the tag on the antenna central axis.
- See the tag datasheet for the distance D.

## 5 Electrical Connections

- The device must be connected by a skilled qualified person.
- Device of protection class III.
- Electric supply via SELV circuits only.
- Disconnect power before connecting the device.
- The IP rating indicated in the data sheet is only guaranteed if the M12 connectors are firmly screwed.
- The device can be damaged by insufficiently tightened M12 connectors.
- Screw the M12 connector to the device applying 1 to 1.5 Nm.

### 5.1 Item 5227U

Connect the **BLUEBOX** to the voltage supply and CAN bus using a suitable M12 CAN bus connection cable.

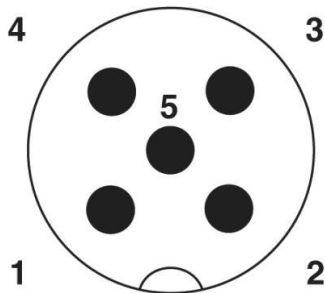

5-poles M12 A-coded male connector

Pin	No	Min	Typical	Max	Description
PE	1				Protected Earth
+ PWR	2	10Vdc	12/24Vdc	36Vdc	DC power supply
- PWR	3				DC power supply return path
CAN H	4				CAN bus connection (CAN H)
CAN L	5				CAN connection (CAN L)
SHIELD	-				Protected Earth





To ensure interference-free operation, the device must be connected to an earth potential free from external voltage.

Hereinafter a cross reference table between connection pin number and the color of the wires of a CAN bus 5-poles cable with 5-poles M12 A-coded female connector and open ended cable.

Pin	No	Wire Cable Color
PE	1	Shield
+ PWR	2	Red
- PWR	3	Black
CAN H	4	White
CAN L	5	Blue

## 6 Status Indications

This section provides details on the status indications of the **BLUEBOX**.

The **BLUEBOX** uses one bicolor green/red LED. The following tables provides the indicator states and flash rates.

LED State	Description
<b>On</b>	The LED shall be constantly on.
<b>Off</b>	The LED shall be constantly off.
<b>Flickering</b>	That shall indicate the iso-phase on and off with a frequency of approximately 10 Hz: on for approximately 50 ms and off for approximately 50 ms.
<b>Blinking</b>	That shall indicate the iso-phase on and off with a frequency of approximately 2,5 Hz: on for approximately 200 ms followed by off for approximately 200 ms.
<b>Single flash</b>	That shall indicate one short flash (approximately 200 ms) followed by a long off phase (approximately 1000 ms).
<b>Double flash</b>	That shall indicate a sequence of two short flashes (approximately 200 ms), separated by an off phase (approximately 200 ms). The sequence is finished by a long off phase (approximately 1000 ms).
<b>Triple flash</b>	That shall indicate a sequence of three short flashes (approximately 200 ms), separated by an off phase (approximately 200 ms). The sequence is finished by a long off phase (approximately 1000 ms).
<b>Quadruple flash</b>	That shall indicate a sequence of four short flashes (approximately 200 ms), separated by an off phase (approximately 200 ms). The sequence is finished by a long off phase (approximately 1000 ms).

Operating Status	LED red	LED green	LED yellow
<b>Preoperational</b>	Off	Blinking	Off
<b>Preoperational and tag detected</b>	Off	Blinking alternately with yellow LED	Blinking alternately with green LED
<b>Operational</b>	Off	On	Off
<b>Operational and tag detected</b>	Off	Off	On
<b>Stopped</b>	Off	Flashes (single flash)	Off

Operating Status	LED red	LED green	LED yellow
Stopped and tag detected	Off	Flashes (single flash) alternately with yellow LED	Flashes alternately with green LED
Configuration or hardware error	Blinking	According to the current operating status	
CAN bus warning limit reached	Flashes (single flash)	According to the current operating status	
Error control event (heartbeat)	Flashes (double flash)	According to the current operating status	
CAN bus off	On	Off	Off
Hardware defect	Off	Off	Off

## 7 Antenna

This section provides details on the antenna of the **BLUEBOX**.

The **BLUEBOX** integrates an RF antenna inside the case.

The read range of an RFID system always depends on various factors like antenna size, transponder size, transponder IC type, orientation between transponder and reader antenna, position of the transponder versus the reader antenna, noise environment, metallic environment, etc. Therefore all data about read ranges can only be typical values measured under laboratory conditions. In real live applications the read range may differ from the data mentioned in the datasheet.

## 8 Maintenance, Repair and Disposal

If used correctly, no maintenance and repair measures are necessary

- The device must only be repaired by the manufacturer.
- After use dispose of the device in an environmentally friendly way in accordance with the applicable national regulations.
- Keep the device free from soiling.
- Do not open the device.

## 9 Regulatory Compliance

This section gives information on the **BLUEBOX** regulatory compliance.

### 9.1 CE Compliance

The **BLUEBOX** is in conformity with the relevant Union harmonisation legislation:

- **2014/53/EU** relating to the making available on the market of radio equipment
- **2014/30/EU** relating to electromagnetic compatibility
- **1999/519/EMC** on the limitation of exposure of the general public to electromagnetic fields

References to the relevant harmonised standards used or references to the other technical specifications in relation to which conformity is declared:

- Safety of Information Technology Equipment
  - EN 62368-1:2014 + AC:2015
- Limitation of human exposure to electromagnetic fields from devices operating in the frequency range 0 Hz to 300 GHz, used in Electronic Article Surveillance (EAS), Radio Frequency Identification (RFID) and similar applications
  - EN 50364:2010
- Electromagnetic Compatibility standard for radio equipment and services
  - EN 301 489-1 V1.9.2
  - EN 301 489-3 V1.6.1
- Radio Frequency Identification Equipment operating in the band 865 MHz to 868 MHz with power levels up to 2 W and in the band 915 MHz to 921 MHz with power levels up to 4 W
  - EN 302 208 V3.1.1
- Degrees of protection provided by enclosures (IP Code)
  - EN 60529:1992 + AC:1993 + A1:2000 + A2:2013

**10 Mechanical Drawings**

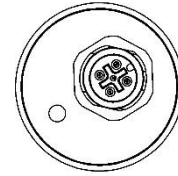
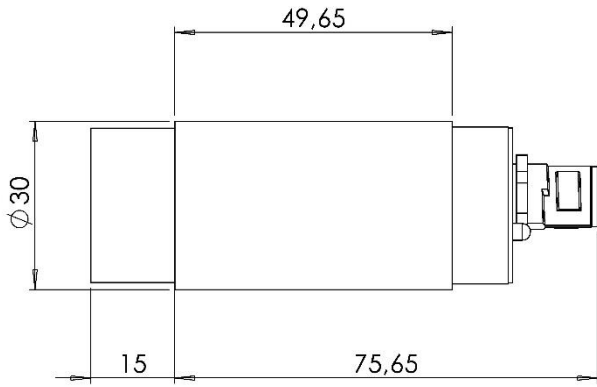

All the dimensions are in mm.

## 11 Document Revision History

Date	Revision	Description
12/09/18	1.00	First release.
22/10/18	1.01	Updated the reader's firmware versions object of this manual in preface section. Added the tag read count info activation flag in RF configuration. Corrections in operating features and configuration parameters.
11/01/19	1.02	Updated the company name/logo and BLUEBOX logo. Updated the reader's firmware versions object of this manual. Added the max RSSI info activation flag in RF configuration.
01/02/19	1.03	Updated the reader's firmware versions object of this manual. Added the Brazil RF region support in RF configuration and in regions of operation appendix. Minor changes and corrections in the configuration parameters. Moved the plans of frequencies from RF configuration section to regions of operations appendix. Moved the power requirements from antennas section to regions of operations appendix.
05/02/19	1.04	Corrected the sub-indexes values in general parameters. Move the tag data bytes limit warning from RF configuration parameters to operating features section.
02/09/19	1.05	First release with hardware version 2 and firmware version 2.xx. Updated the reader's firmware versions object of this manual. Changes and document fixes in all sections.
17/02/20	1.06	Replaced ISO 18000-6C with ISO 18000-63. ISO 18000-6C became ISO 18000-63 in 2012 due to ISO naming rules that do not allow letters in standards names. Added the installation section. Added safety informations in electrical connections section. Added the maintenance, repair and disposal section.



---

Date	Revision	Description
		Added the regulatory compliance section.

## A. Regions of Operation

The **BLUEBOX** reader has been designed to work in various regions with differing frequency requirements. This document covers operation in North America and Europe.

### A.1. Operation in Europe

For European operation, the **BLUEBOX** reader supports the frequency plan listed in the table below and is compliant with the ratified ETSI EN 302-208 specification V.3.1.0. This specification states that no listen-before-talk is performed, the maximum continuous transmit time on a channel is four seconds, and the reader enforces the 100 ms off time before reusing the same channel. In some applications (i.e. conveyor systems) it may be necessary for interrogators to transmit while tags are not present. To accommodate such requirements, the device shall include within interrogators a means to minimize the overall length of transmission commensurate with the application. This may include the provision of trigger mechanisms within interrogators to initiate transmissions.

RF Channel	Frequency [MHz]
4	865.7
7	866.3
10	866.9
14	867.5



According to ETSI EN 302208-1 only channels 4, 7, 10 and 13 (internal numerated as 1, 4, 7 and 10) could be used at high power! Other RF channels are present only for test purposes and should not be used in normal operation!

European regulations describe radiating power limits in relation to dipole antenna and ERP (Efficient Radiating Power) is used as a measure. The maximum RF output power is defined by the antenna gain, the half power beam width and the cable attenuation on the reader - antenna connection. For antennas with a half power beam width of up to 70° a power of  $P_{ERP,max} = 2W$  ERP is allowed. For other half power beam widths a reduced power of  $P_{ERP,max} = 0.5W$  ERP. The maximum **BLUEBOX** RF output power is defined as:

$$P_{C,max} = P_{ERP,max} - G_{IC} + 5.15 + C_L$$

Where:

$P_{C,max}$	Maximum RF output power in dBm
$P_{ERP,max}$	Maximum ERP power of the antenna in dBm
$G_{IC}$	Circular antenna gain in dBic
$C_L$	Cable loss in dB

A.2. Operation in North America

The FCC specifies frequency hopping across the North American spectrum allocated to UHF RFID (902–928 MHz, with hopping occurring between 902.75–927.25 MHz in 500 KHz steps). This specification states that no listen-before-talk is performed, the maximum continuous transmit time on a channel is 0.4 seconds.

RF Channel	Frequency [MHz]
1	902.75
2	903.25
3	903.75
...	...
49	926.75
50	927.25



Other RF channels and single channel selection are present only for test purposes and should not be used in normal operation!

FCC regulations describe the radiating power limits in relation to isotropic antenna and EIRP (Efficient Isotropic Radiating Power) is used as a measure. The maximum RF output power is defined by the antenna gain, the half power beam width and the cable attenuation on the reader - antenna connection. A power of  $P_{EIRP,max} = 36\text{dBm}$  EIRP subject to a maximum conducted power of allowance of 30dBm at the antenna connector is allowed. The maximum **BLUEBOX** RF output power is defined as:

$$P_{C,max} = P_{EIRP,max} - G_{IC} - 2.15 + 5.15 + C_L$$

Where:

$P_{C,max}$	Maximum RF output power in dBm
$P_{ERP,max}$	Maximum ERP power of the antenna in dBm
$G_{IC}$	Circular antenna gain in dBic
$C_L$	Cable loss in dB

### A.3. Operation in Brazil

The BLUEBOX operates over a subset of the FCC North American spectrum (902–928 MHz, with specific frequency and channel usage dictated by regulations of each country. Frequency hopping spread spectrum (FHSS) is used. No listen-before-talk is performed, the maximum continuous transmit time on a channel is 0.4 seconds.

RF Channel	Frequency [MHz]
1	902.75
2	903.25
3	903.75
4	904.25
5	904.75
6	905.25
7	905.75
8	906.25
9	906.75
10	907.25
26	915.25
27	915.75
28	916.25
29	916.75
30	917.25

RF Channel	Frequency [MHz]
31	917.75
32	918.25
33	918.75
34	919.25
35	919.75
36	920.25
37	920.75
38	921.25
39	921.75
40	922.25
41	922.75
42	923.25
43	923.75
44	924.25
45	924.75
46	925.25
47	925.75
48	926.25
49	926.75
50	927.25



Other RF channels and single channel selection are present only for test purposes and should not be used in normal operation!

Brazil regulations describe the radiating power limits in relation to isotropic antenna and EIRP (Efficient Isotropic Radiating Power) is used as a measure. The maximum RF output power is defined by the antenna gain, the half power beam width and the cable attenuation on the reader - antenna connection. A

power of  $P_{EIRP,max} = 36\text{dBm}$  EIRP subject to a maximum conducted power of allowance of  $30\text{dBm}$  at the antenna connector is allowed. The maximum **BLUEBOX** RF output power is defined as:

$$P_{C,max} = P_{EIRP,max} - G_{IC} - 2.15 + 5.15 + C_L$$

Where:

$P_{C,max}$	Maximum RF output power in dBm
$P_{ERP,max}$	Maximum ERP power of the antenna in dBm
$G_{IC}$	Circular antenna gain in dBic
$C_L$	Cable loss in dB